

FURUNO

OPERATOR'S MANUAL

**INMARSAT MINI-C
MOBILE EARTH STATION**

MODEL FELCOM 16



FURUNO ELECTRIC CO., LTD.
NISHINOMIYA, JAPAN

© **FURUNO ELECTRIC CO., LTD.**

9-52 Ashihara-cho,
Nishinomiya, Japan

Telephone : 0798-65-2111
fax : 0798-65-4200

Your Local Agent/Dealer

All rights reserved.

Printed in Japan

PUB.No. OME-56380

(DAMI) FELCOM16

FIRST EDITION : MAY. 2003

B : SEP. 09,2003



* 0 0 0 8 0 9 3 4 5 0 1 *



* O M E 5 6 3 8 0 B 0 0 *



SAFETY INSTRUCTIONS

WARNING



Do not open the equipment.

Hazardous voltage which can cause electrical shock, burn or serious injury exists inside the equipment. Only qualified personnel should work inside the equipment.



Hazardous microwave. Do not approach within 60 cm of the antenna radome when it is transmitting.

Microwave radiation can be harmful to the human body, particularly the eyes.

Radiation Level	At
10W/m ²	60 cm

Do not disassemble or modify the equipment.

Fire, electrical shock or serious injury can result.

Turn off the power immediately at the ship's mains switchboard if water leaks into the equipment or the equipment is emitting smoke or fire.

Continued use of the equipment can cause fire or electrical shock.

Any repair work must be done by a licensed radio technician.

Improper repair work can cause electrical shock or fire.

CAUTION

Use the proper fuse.

Use of a wrong fuse can result in fire or permanent damage to the equipment.

This equipment is intended for marine application.

WARNING LABEL

A warning label is attached to the communication unit. Do not remove the label. If the label is missing or damaged, contact your dealer about replacement.

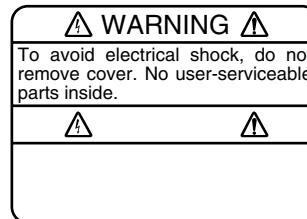

Name: Warning Label (1)
Type: 86-003-1011-1
Code No.: 100-236-231

TABLE OF CONTENTS

FOREWORD	vi
SYSTEM CONFIGURATION.....	viii
INMARSAT C SYSTEM OVERVIEW	ix
1. OPERATIONAL OVERVIEW.....	1-1
1.1 Communication Unit.....	1-1
1.1.1 Turning the power on/off	1-1
1.1.2 Diagnostics	1-1
1.2 Terminal Unit (PC) Operation.....	1-2
1.2.1 Starting, quitting the application	1-2
1.2.2 Controls description	1-3
1.2.3 Shortcut keys.....	1-4
1.2.4 Function keys.....	1-5
1.3 Standby Display.....	1-6
1.3.1 Display indications	1-7
1.4 Menu Overview	1-11
1.5 Error Messages and Alerts	1-12
1.6 Choosing a Printer.....	1-13
2. SYSTEM INITIALIZATION	2-1
2.1 System Settings	2-1
2.2 PC Window Setup	2-3
2.3 Login and Logout.....	2-5
2.3.1 Login.....	2-5
2.3.2 Logout.....	2-7
2.4 EGC Settings	2-8
2.4.1 What is the EGC (Enhanced Group Call) service?	2-8
2.4.2 EGC setup	2-10
2.4.3 Adding EGC channels.....	2-13
2.4.4 Saving, printing EGC messages automatically.....	2-15
2.5 Adding NCS Channels.....	2-17
2.6 LES List.....	2-19
2.6.1 Setting toll charges	2-19
2.6.2 Registering LES to LES list.....	2-21
2.6.3 Editing the LES list.....	2-22
2.6.4 Printing the LES list.....	2-23
2.7 Station List.....	2-24
2.7.1 Adding stations to the station list.....	2-24
2.7.2 Editing the station list	2-28
2.7.3 Printing the station list.....	2-29
2.8 Entering Own Ship's Position	2-30
2.9 Creating A Directory	2-31
2.9.1 Creating a directory where to store messages	2-31
2.9.2 Specifying directory where to store messages	2-33

2.10 E-mail Service List	2-34
2.11 E-mail Setup	2-37
2.12 Saving, Loading System Settings.....	2-38
2.12.1 Saving system settings to a floppy disk	2-38
2.12.2 Loading system settings to the terminal unit.....	2-38
3. FILE OPERATIONS.....	3-1
3.1 Files and Working Areas	3-1
3.2 Preparing Files.....	3-2
3.2.1 Preparing a routine file	3-2
3.2.2 Preparing a confidential file	3-3
3.2.3 Editor menu setup	3-4
3.2.4 Working with text	3-5
3.3 Saving Files	3-10
3.3.1 Save file, retain place on screen.....	3-10
3.3.2 Save file, clear screen	3-11
3.4 Opening Files	3-12
3.4.1 Opening files	3-12
3.4.2 Switching between files	3-12
3.4.3 Opening a file when both working areas are occupied.....	3-13
3.5 Saving a File Under a New Name	3-14
3.6 Printing Files.....	3-15
3.7 Combining Files	3-15
3.8 Deleting Files.....	3-16
3.9 Renaming Files.....	3-17
3.10 Decoding E-mail Attachment.....	3-18
4. INMARSAT C COMMUNICATIONS	4-1
4.1 Transmitting	4-1
4.1.1 Code description	4-1
4.1.2 Transmitting prepared message	4-2
4.1.3 Transmitting a file stored on the hard disk	4-15
4.1.4 Canceling transmission on a message awaiting transmission.....	4-16
4.1.5 Requesting delivery status	4-17
4.1.6 Accessing the code number services	4-20
4.1.7 Displaying the send message log	4-22
4.2 Receiving.....	4-23
4.2.1 When a message is received.....	4-23
4.2.2 Setting the receive alarm.....	4-24
4.2.3 Displaying, printing received messages.....	4-24
4.2.4 Automatically printing received messages.....	4-28
4.2.5 Saving received messages to the hard disk.....	4-28
4.2.6 Automatically saving received messages to the hard disk	4-29
4.2.7 Deleting received messages	4-30
4.3 Display Log	4-31
4.3.1 Displaying and printing the display log.....	4-31
4.3.2 Automatic printing of display log	4-32

TABLE OF CONTENTS

4.4	EGC Messages	4-33
4.4.1	Displaying and reprinting EGC messages.....	4-33
4.4.2	Displaying EGC closed network ID (ENID).....	4-34
4.4.3	Displaying the EGC message log.....	4-35
5.	DATA REPORTING AND POLLING	5-1
5.1	Data Reporting	5-1
5.1.1	Setting a data report	5-2
5.1.2	Setting a message report.....	5-4
5.1.3	Automatic printing of data report, polling command.....	5-7
5.2	Polling	5-8
5.2.1	Polling commands.....	5-8
5.2.2	Other polling commands	5-10
5.2.3	Polling reception	5-11
5.3	DNID (Data Network Identification).....	5-12
5.3.1	Displaying DNID	5-12
5.3.2	Enabling/Disabling DNID.....	5-13
6.	OTHER FUNCTIONS	6-1
6.1	Aborting an Operation	6-1
6.2	Scanning NCS Common Channel	6-2
6.3	Choosing EGC Receiving Channel.....	6-3
6.4	Choosing NCS Channel	6-4
6.5	LES Information	6-5
7.	MAINTENANCE, TROUBLESHOOTING.....	7-1
7.1	General Checking and Maintenance.....	7-1
7.2	Diagnostics.....	7-2
7.2.1	Self test at power on	7-2
7.2.2	Testing the communication unit through the keyboard, displaying program version no.	7-2
7.3	Performance Verification (PV) Test.....	7-4
7.3.1	PV test sequence.....	7-4
7.3.2	PV test procedure	7-5
7.3.3	Results of PV test	7-6
7.4	System Status Monitor.....	7-7
7.5	Replacing the Fuse	7-8
7.6	Error Messages	7-9
7.6.1	Equipment trouble messages.....	7-9
7.6.2	Warning messages	7-10

APPENDIX AP-1

Menu Tree..... AP-1

International Telex/Telephone Country Code List AP-8

LES List AP-15

International Telex Abbreviations..... AP-16

International Telegraphy Alphabet AP-17

Messages AP-18

Parts List..... AP-21

Parts Location..... AP-22

SPECIFICATIONS SP-1

INDEX..... IN-1

FOREWORD

Introduction

FURUNO Electric Company thanks you for considering and purchasing the FELCOM 16 Inmarsat Mini-C Mobile Earth Station. We are confident you will discover why the FURUNO name has become synonymous with quality and reliability.

The FELCOM 16 mainly consists of a communication unit and an antenna unit. Connected to a PC (local supply), the FELCOM 16 provides a wide range of communication services, such as e-mail and telex, for mobile and fixed terrestrial subscribers in the Inmarsat C communication network. Its compact size permits installation where space is limited.

FURUNO designs and manufactures this equipment with much attention to operation and maintenance simplicity. However, please read and follow the recommended procedures for operation and maintenance to get the most out of the equipment.

This manual provides a brief introduction to the Inmarsat C system (pages ix thru xiv). For more detailed information, refer to the information below.

*Inmarsat C Maritime Customer Relations Officer
Maritime Services Operations Department
International Maritime Satellite Organization (Inmarsat)*

*Address: 99 City Road, London, EC1Y 1AX, UK
Telephone: +44 20 7728 1777 (Switchboard)
Fax: +44 20 7728 1142
URL: www.inmarsat.com
E-mail: customer_care@inmarsat.com*

Features

- ◆ E-mail facility. (To transmit E-mail, register with an LES provider which provides e-mail services. E-mail charges are calculated separately.)
- ◆ Built-in Enhanced Group Call (EGC) receiver. May be set to operate as EGC-only receiver.
- ◆ Store-and-forward telex communication (public telex network)
- ◆ Data reporting and Polling
- ◆ Diagnostic programs for maintenance
- ◆ Menu driven operation
- ◆ VMS (Vessel Monitoring System) applicable

Program Number

PC Board	Program No.	Version No.	Date of Modification
TERMINAL	1650166	01	
RF CON CPU	1650160	01	

SYSTEM CONFIGURATION

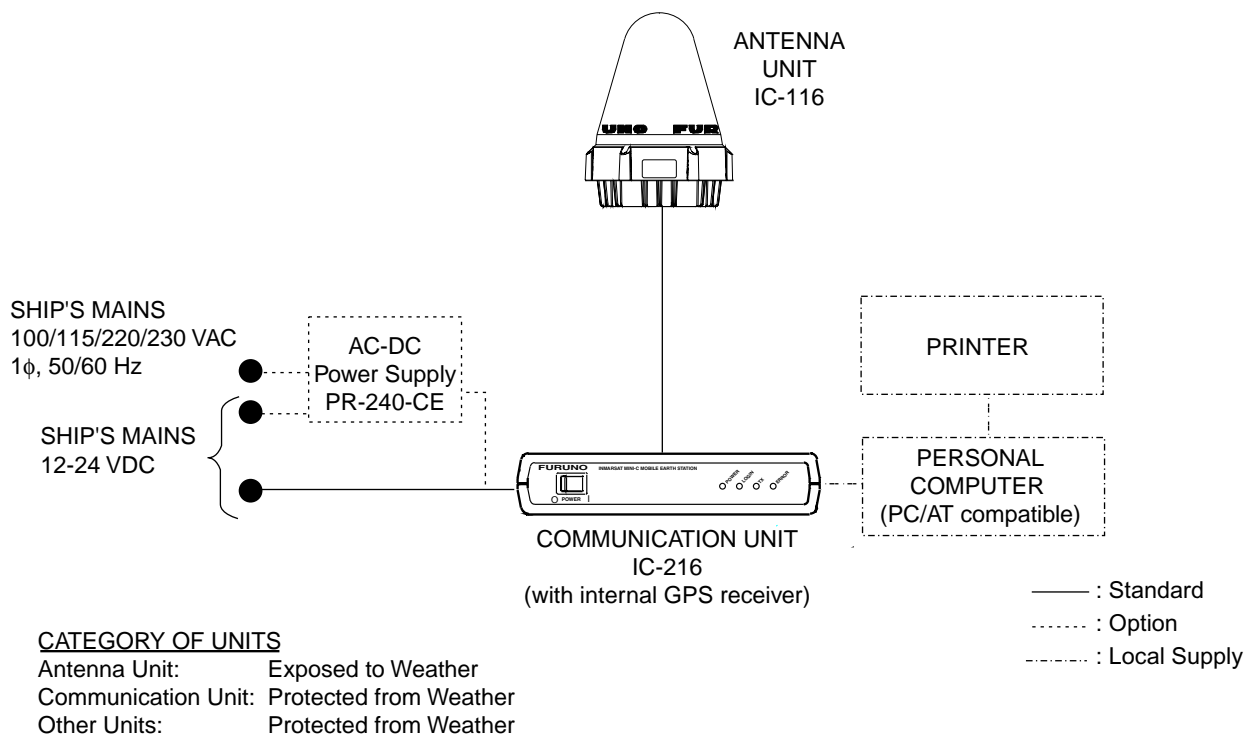

INMARSAT C SYSTEM OVERVIEW

Introduction

The Inmarsat C system provides worldwide telex and data transmission and reception of written information to owners of an Inmarsat C transceiver or a terrestrial telex network via satellite. Further, e-mail may be sent via the internet.

Communication mode is store-and-forward telex, which means all information sent are first stored at an LES and then delivered to designated party.

An EGC (Enhanced Group Call) receiver is built in the FELCOM 16 to receive the following types of messages, broadcast by LESs:

- ◆ SafetyNET™-governments and maritime authorities can use this service to distribute maritime safety information to ships within selected areas.
- ◆ FleetNET™-commercial subscription organizations or shipping companies can use this service to transmit trade information (for example, company news or market prices) simultaneously to a selected group of ships, to provide up-to-the-minute information.
- ◆ EGC system-related is sent by Inmarsat to certain shipping companies and geographical areas.

Besides its primary application of ship-shore, shore-ship or ship-ship communications, the Inmarsat C service has also proved beneficial to trucking firms who have found it indispensable for communicating with their vehicles. In this manual, however, we will concentrate on ship applications, the main application.

Inmarsat C System Configuration

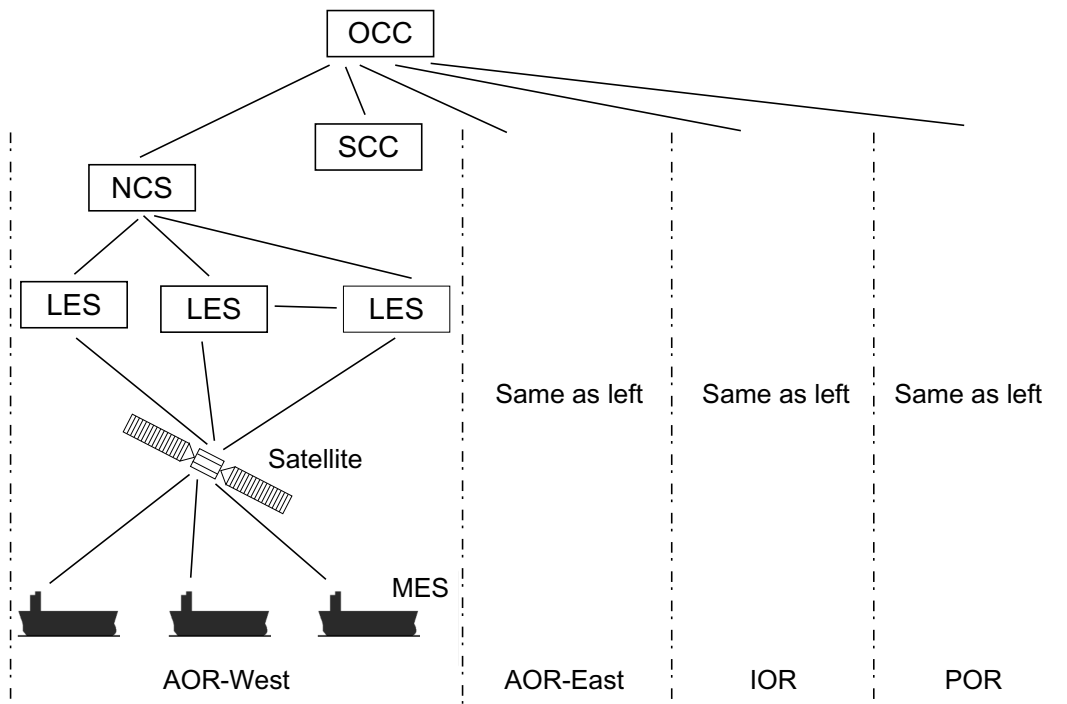

OCC: Operation Control Center
SCC: Satellite Control Center
NCS: Network Coordination Station
MES: Mobile Earth Station
LES: Land Earth Station

Inmarsat C system configuration

The Inmarsat C system consists of the Operation Control Center (OCC), Satellite Control Centers (SCC), Network Coordination Stations (NCS), Land Earth Stations (LES) and Mobile Earth Stations (MES). The OCC, located at Inmarsat's London headquarters, coordinates a wide range of activities in the Inmarsat system, including commissioning of mobile earth stations.

The Inmarsat C system divides the world into four regions and each region is covered by its own satellite.

Inmarsat system satellites

Region	Satellite	Satellite Position
AOR-West	Inmarsat 3, F4	54.0°W
AOR-East	Inmarsat 3, F2	15.5°W
IOR	Inmarsat 3, F1	64.0°E
POR	Inmarsat 3, F3	178.0°E

In each region there is one NCS and several LESs. The NCS keeps track of all Inmarsat C transceivers in its region and broadcasts information such as navigational warnings, weather reports and news. The LESs provide the link between the MES and the terrestrial telecommunications networks via satellite.

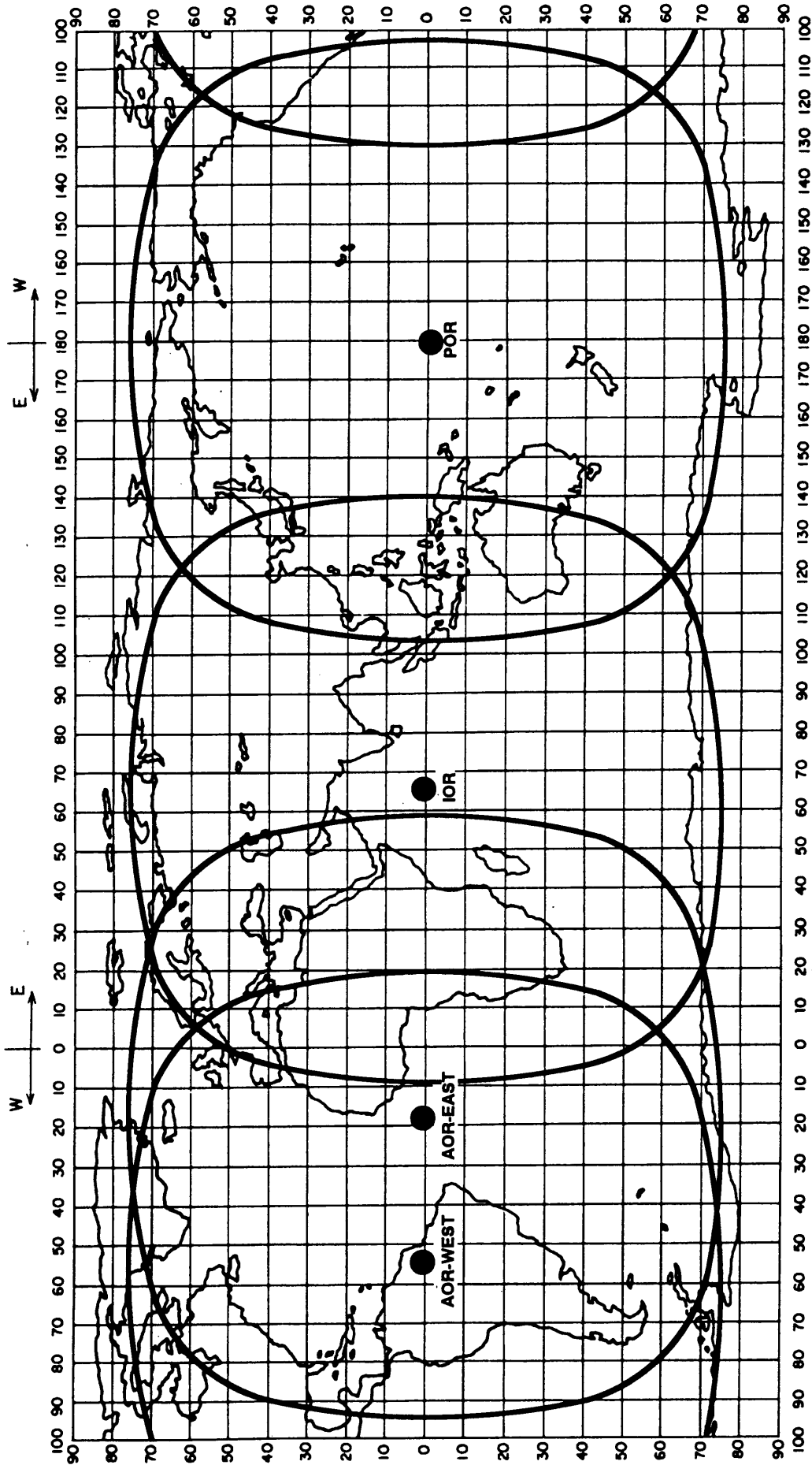

AREA	SATELLITE NAME	POSITION
POR	INMARSAT-3, F3	178°E
IOR	INMARSAT-3, F1	64.0°E
AOR-EAST	INMARSAT-3, F2	15.5°W
AOR-WEST	INMARSAT-3, F4	54.0°W

Coverage area of Inmarsat satellites

Communications Network

The illustration below shows the Inmarsat C communications network.

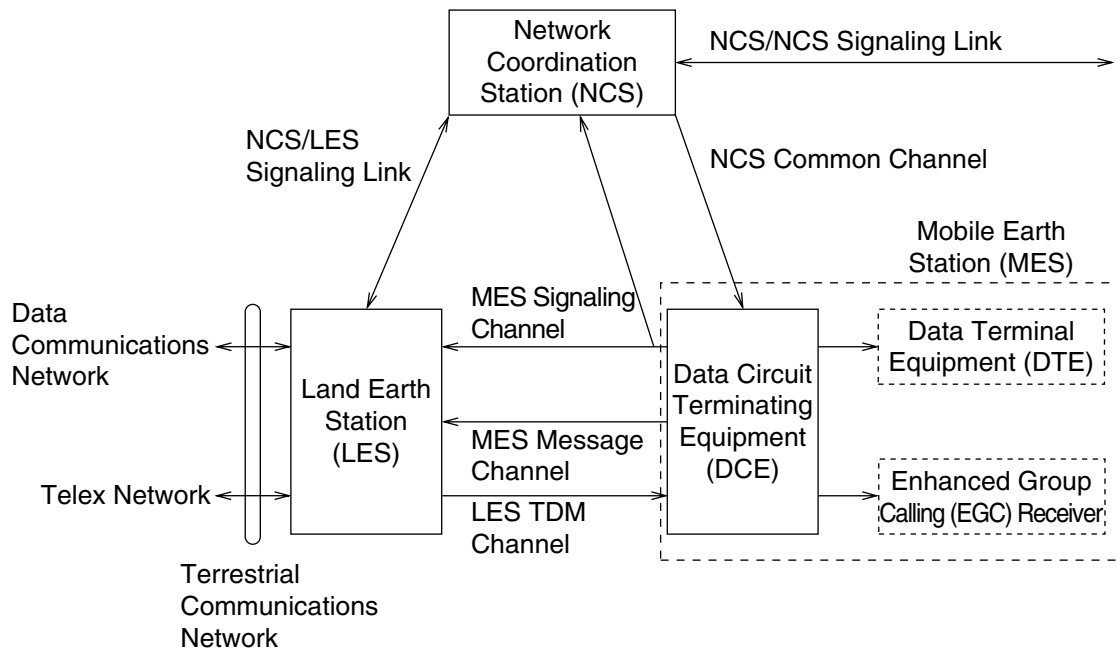

Inmarsat C communications network

NCS common channel	The NCS has two major functions: 1) Transmitting information on a common channel. 2) Transmitting EGC messages to MESs.
NCS/LES signaling link	This is the link between NCS and all LESs in its region. All EGC messages pass through this link.
LES TDM channel	This channel carries the circuit control signal for MES and transmits messages from LES to MES.
MES message channel	This channel carries messages from MES to LES.
MES signaling channel	This channel transmits requests, data reports, etc. In addition, it carries login and logout from MES to NCS.
NCS/NCS signaling link	This is the link between NCSs. It exchanges data between MESs operating in different ocean regions.
MES interface	The MES consists of the Data Circuit Terminating Equipment (DCE) and the Data Terminal Equipment (DTE). The DCE consists of the antenna unit, and the DTE consists of the communications unit and terminal unit (PC).
Terrestrial network interface	The major functions of the LESs are: 1) Telex store-and-forward conversion 2) Handling EGC messages 3) Data Reporting and Polling 4) Distress message processing

Types of MES

There are three types of MES: class 1, class 2 and class 3. This FELCOM 16 is a class 2 MES.

Class 1: 1) Transmits messages to LES

2) Receives messages from LES

Class 2: 1) The functions of class 1 plus operation as an EGC receiver when not transmitting or receiving.

2) EGC-only receiver

Class 3: The function of class 1 plus simultaneous operation as an EGC-only receiver.

1. OPERATIONAL OVERVIEW

1.1 Communication Unit

The communication unit is the heart of the FELCOM 16 system, transmitting and receiving messages via the Inmarsat system.

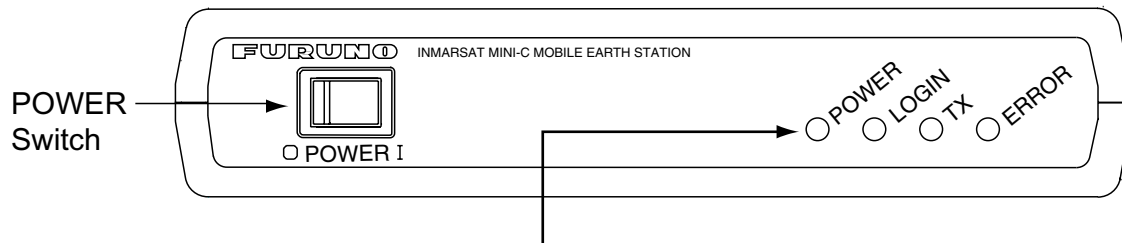

Status LEDs

POWER: Lights (in green) when power is on.

LOGIN: Lights (in green) when logged in;
flashes (in green) in green in other instances.

TX: Lights (in green) when transmitting.

ERROR: Flashes (in red) for equipment error.

Communication unit IC-216

1.1.1 Turning the power on/off

Press the [POWER] switch to power the communication unit and antenna on or off.

Note: The example screens shown in this manual may not match the screens you see on your display. The screen you see depends on your system configuration and equipment settings.

1.1.2 Diagnostics

When the communication unit is turned on it automatically conducts a series of diagnostic tests to check itself for proper operation. The test takes about 30 seconds and all lamps are on during the test. For further details, see Chapter 7.

1.2 Terminal Unit (PC) Operation

All operations are carried out from the terminal unit (local supply), through an easy-to-follow menu system. In this manual the PC is referred to as “Terminal Unit.” Note that it is necessary to supply a printer.

PC requirements

- Operating system: Windows98, Windows 2000, Windows ME or Windows XP
- Memory: At least 32 MB
- Free space in hard disk: At least 20 MB
- CPU: Pentium 100 MHz or higher
- Floppy disk drive

Windows is a registered trademark of Microsoft Corporation in the US and other countries used under license.

1.2.1 Starting, quitting the application

For information about terminal unit operation see the PC’s owner’s manual.

1. Turn on the communications unit.
2. Turn on the terminal unit.
3. Double-click the F16PC icon to start the application. After the program has been loaded the standby display appears. For details about the standby display see paragraph 1.3.



F16PC

F16PC icon

Note: The example screens shown in this manual may not match the screens you see on your display. The screen you see depends on your system configuration and equipment settings.

4. To quit the application, press the [F12] key while pressing the [Alt] key. The following display appears. (You may also quit the application by clicking the Close button at the top right corner of the screen.)

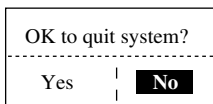

5. Press the [←] key to choose Yes and then press the [Enter] key.
6. Turn off the terminal unit in accordance to Windows operating procedure.
7. Turn off the communications unit.

Note: If a different method is used to quit the application, any settings changed before quitting will not be saved.

1.2.2 Controls description

The FELCOM 16 is almost 100% keyboard controlled. Operation is carried out with the function keys, numbered F1-F10 at the top of the terminal unit's keyboard.

Controls

Esc	Cancels key input and returns to previous display screen.
F1-F10	These are the function keys. They choose menus.
Backspace	Deletes the character to the left of the cursor.
Insert	Works the same as "paste." See "Copying and pasting text" in paragraph 3.2.4.
Delete	Deletes the character selected with the cursor.
Home	Moves the cursor to the top of the message being edited.
End	Moves the cursor to the bottom of the message being edited.
PgUp	Goes to the previous page of the edit screen.
PgDn	Goes to the next page of the edit screen.
[↑], [↓], [←], [→]	Control the cursor.
Enter	Registers key input.
Shift	Chooses upper or lower case alphabet. Press and hold down the key and then press the [Caps Lock] to get upper or lower case alphabet. Note that only upper case alphabet are used in telex.
Alt	Executes the shortcut key operation when combined with an alphabet key. See paragraph 1.2.3.
Space Bar	Inserts a space. In addition, it displays the file list, a partial view of a file, etc., depending on menu.
Caps Lock	Turns upper case alphabet input on or off. The Caps Lock LED lights when upper case input is on.
Tab	Inserts horizontal tab characters. The number of tab characters the key can insert per line of text can be programmed for two, four or eight tabs.

1. OPERATIONAL OVERVIEW

- Ctrl** Works in combination with alphabet keys as follows:
Ctrl + [M]: Same as Enter.
Ctrl + [H]: Same As Back Space.
Ctrl + [I]: Same as Insert.
Ctrl + [V]: Same as Overwrite+Insert.
- Num Lock** Turns numeric input on or off. Note that you cannot enter alphabet when the Num LED is lit.

Note: In telex, lower case, #, &, *, \$, @, %, etc. are not used. A full list of characters useable in telex appears in the Appendix. For e-mail any character or symbol may be used.

1.2.3 Shortcut keys

The FELCOM 16 provides the keyboard shortcuts shown below for commonly used functions.

Shortcut keys

Shortcut key	Function
[Alt]+[N]	Same as New in File menu
[Alt]+[O]	Same as Open in File menu
[Alt]+[Q]	Same as Close in File menu
[Alt]+[D]	Same as Delete in File menu
[Alt]+[S]	Same as Save in File menu
[Alt]+[P]	Same as Print in File menu
[Alt]+[X]	Same as Undo
[Delete]	Same as Cut in Edit menu
[Alt]+[C]	Same as Copy in Edit menu
[Insert]	Same as Paste in Edit menu
[Alt]+[V]	Same as Change Window in Edit menu

1.2.4 Function keys

The function menus, which you access by pressing the function keys (F1-F10) at the top of the keyboard, control most operations of this unit.

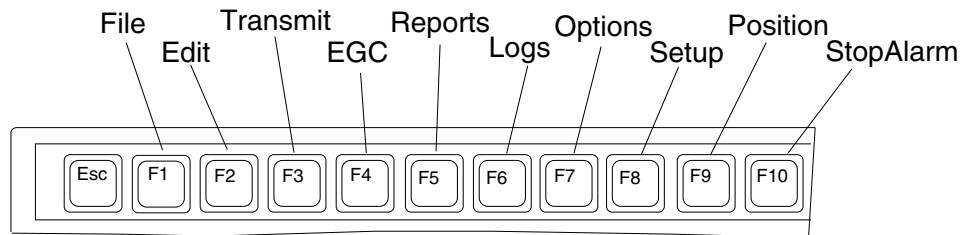

Keyboard

Function key description

Menu	Description
File (F1)	Processes files.
Edit (F2)	Provides text editing facilities.
Transmit (F3)	Transmits messages.
EGC (F4)	Sets up EGC message facilities.
Reports (F5)	Sets up data reporting function.
Logs (F6)	Displays sent and received message logs.
Options (F7)	Login, logout; testing facilities.
Setup (F8)	Sets up the system.
Position (F9)	Enter your ship's position manually.
Stop Alarm (F10)	Silences audio alarm.

1.3 Standby Display

After the equipment is turned on and the diagnostic test has been conducted, the standby display appears, showing the system status monitor. The system status monitor provides various operating information. For a detailed description, see paragraph 7.4.

File	Edit	Transmit	EGC	Reports	Logs	Options	Setup	Position	StopAlarm
Date			02-02-25			BBER		IMN: 443156710	
Time			01:32 (UTC)			C/N		000	
Position			LAT 34:30.00N			Send Level		OK (0dB)	
Waypoint			LON 135:00.00E			Rx AGC Level		OK (0)	
Course			LAT			REF Offset Freq		OK (135)	
Speed			LON			Synthe		OK (0Hz)	
Current NCS			345 DEG					OK	
Current Channel			10.2 KTS						
Current TDM			344 (IOR) LOGOUT			Antenna Power Supply		OK	
MES Status			NCS CC						
GPS Status			NCS CC			Water Temperature		DEG	
DCE Memory			Idle			Water Current			
			2D			Direction		DEG	
			32818 Bytes free			Speed		KTS	
						Depth			
Current State: IDLE				UNSYNC		02-02-25 01:32 (UTC)			
DCE F16 Ver. ##				NCS: IOR LOGOUT		LAT: 34:30.00N			
						LON: 135:00.00E			

= Version No. of RF CON Board

Standby display

After the diagnostic test has been completed, the equipment automatically starts synchronizing itself with a satellite. When the indication “Retuning” is replaced with “ SYNC(NCS), the synchronization process is completed. Then, you are ready to receiving EGC messages. For further details see paragraph 2.4.

1.3.1 Display indications

The display is divided in three sections:

- 1) The function menu area
- 2) The working area
- 3) The operating status area

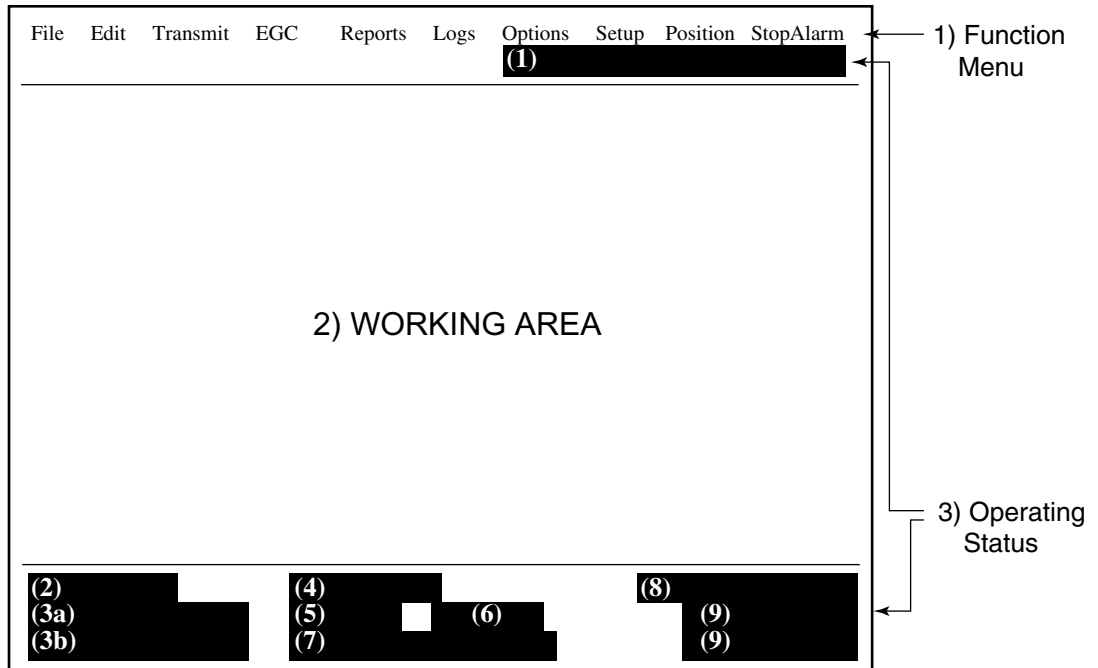

Location of display indications

Below are the indications and meanings of the items in parentheses in the illustration above.

(1) Communication network mode

No display	Normal operation
Restoration Mode (Flashing)	Problem at NCS
Restoration Mode (Reverse video)	Previously designated LES is transmitting the NCS common channel signal.

1. OPERATIONAL OVERVIEW

(2) Communication unit status

IDLE	Idle (awaiting receiving, awaiting transmitting)
IDLE (PENDING)	Awaiting reply from LES
SENDING	Sending
RECEIVING	Receiving
LOGIN	Logged in with NCS
LOGOUT	Logging out with NCS
Data Report	Sending data report
TESTING	PV (Performance Verification) testing
TEST SETUP	Requesting PV testing
SCANNING	NCS scanning
EGC RECEIVER (Reverse video)	EGC-only receiver operation
Delivery Status Req.	Transmitting delivery status request
Forced Clearing	Stopping receiving, transmitting, or scanning

(3a) Communication status

CALLING	Now calling
WAITING FOR ACKNOWLEDGEMENT	Waiting for acknowledgement from LES.
RECEIVING EGC MESSAGE	Now receiving EGC message
WAITING FOR BACKOFF	Waiting to transmit data report
Successful Login.	Login was successful
Login failed.	Login failed
Successful Logout.	Logout was successful
Logout failed.	Logout failed
Successful Forced Clearing.	Forced clearing successful
Forced Clearing Failed.	Forced clearing unsuccessful
SENDING MESSAGE PACKETS	Sending TX message packets
WAITING FOR ACKNOWLEDGEMENT	Waiting for acknowledgement from LES
Successful sending to LES.	Message successfully sent to LES
Sending message failed.	Message could not be sent to LES
Call rejected.	LES rejected your message
Call pending.	LES temporarily suspending communications
Received Call.	Call received from LES
Received Call(ITA2).	Call(ITA2) received from LES
RECEIVING MESSAGE PACKETS	Receiving message packets
CLEARING	Clearing TX sequence
Successful receiving.	You successfully received message
Receiving failed.	You could not receive message
Successful Data Report.	Data report successfully sent.
Data Report failure.	Data report could not be sent.
PV TEST CALL is rejected.	PV test call rejected by NCS
PV TEST CALL is pending.	PV test pending by LES
TEST-RECEIVING MESSAGE	Receiving test message from LES
TEST-SENDING MESSAGE	Sending test message to LES

TEST-DISTRESS ALERT	Sending test distress alert to LES
WAITING FOR ACTIVATION	Waiting start of PV test
WAITING FOR TEST RESULT	Waiting for results of PV test
CLEARING	Clearing PV test
PV TEST is Completed.	PV test is completed.
PV TEST Failure.	PV test failed.

(3b) RF CON board program version number

DCE F16 Ver. XX (XX = Version Number)

(4) Frame synchronization

Blank	Changing channel, or during transmission
SYNC (NCS)	Synchronizing with NCS
SYNC (LES)	Synchronizing with LES
MES Sig. Ch	Transferring to MES signaling channel
MES Msg. Ch	Transferring to MES message channel
UNSYNC	Out of synchronization
Retuning	Synchronizing with NCS or LES

(5) Ocean region receiving

No display	Out of synch with satellite
AOR-W	Atlantic Ocean Region-West
AOR-E	Atlantic Ocean Region-East
IOR	Indian Ocean Region
POR	Pacific Ocean Region

(6) Logging status

LOGOUT	Logged out with ocean region
LOGIN	Logged in with ocean region
LOGIN (Flashing)	Logging in with ocean region

1. OPERATIONAL OVERVIEW

(7) Other information

No display	No receive message in memory, or printer is operating.
REC. MESSAGE EXISTS (Reverse video)	Displayed when a routine message has not been printed, or a confidential message is received.
Data Report (Reverse video)	When data reporting is activated.
Message Report (Reverse video)	Message report setting is activated.

(8) Date and time

Date and time, received from the GPS navigator, are displayed. Manually input date and time are also displayed.

(9) Ship's position

Ships position, received from the GPS navigator, is displayed in latitude and longitude and updated every 30 seconds, or manually input position is displayed.

1.4 Menu Overview

Operation of the FELCOM 16 is carried out through a menu system which you access with the function keys at the top of the screen. The example below shows how to choose menu options from the Editor Setup menu.

1. Press the [F8] key to display the Setup menu.

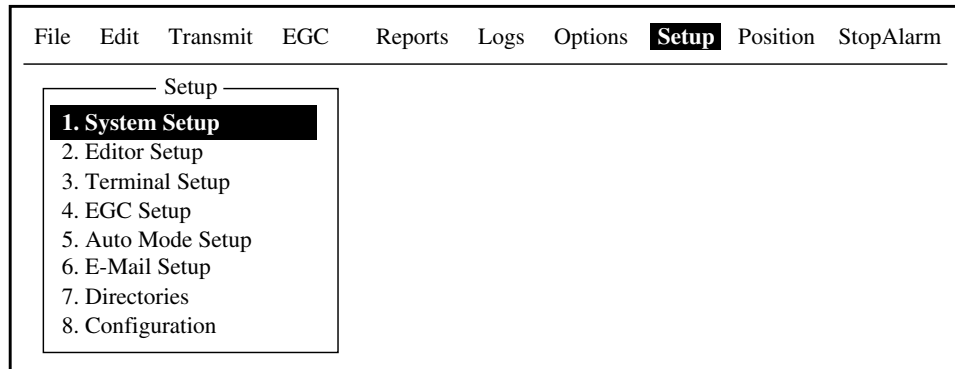

Setup menu

2. Choose desired menu by pressing appropriate numeric key. For example, press the [2] key to show the Editor Setup menu.

Note: You may also choose a menu by pressing the [↑] or [↓] key to choose it and then pressing the [Enter] key.

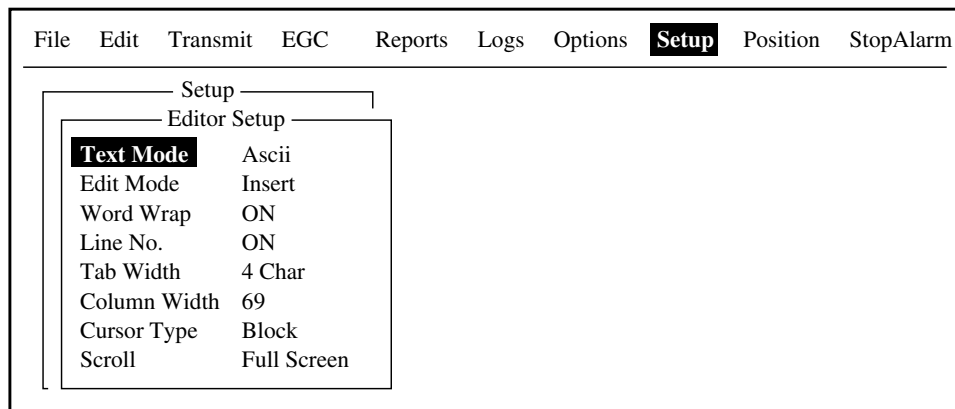

Editor setup menu

3. Choose desired menu item by pressing the [↑] or [↓] keys followed by the [Enter] key. A window displaying the options for the item selected or a alphanumeric data entry window appears depending on your selection. For example, choose Word Wrap.



Word wrap options window

1. OPERATIONAL OVERVIEW

3. Press the [↑] or [↓] key to choose option desired and press the [Enter] key.
4. Press the [Esc] key.

Note 1: On some menus the update window appears after you press the [Esc] key. This is done to ask you to confirm settings. Yes is selected in the Update window; press the [Enter] key to register settings, or press [→] to choose No and press the [Enter] key to escape.

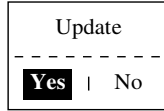

Note 2: The following functions are not available:

<u>Keying Sequence</u>	<u>Item</u>
F3-1	Selection of Priority on Transmit Message
F8-1	NAV PORT, MESSAGE OUTPUT PORT, ACTIVE PORT, EGC OUTPUT PORT, NETWORK SETUP on System Setup menu
F8-4	Waypoint on EGC Setup

1.5 Error Messages and Alerts

The terminal unit displays error messages and alerts to call your attention to misoperation, failed operation and system error. A list of error messages appears in Chapter 7 and alerts in the Appendix.

To erase an error message or alert, press the [Esc] key.

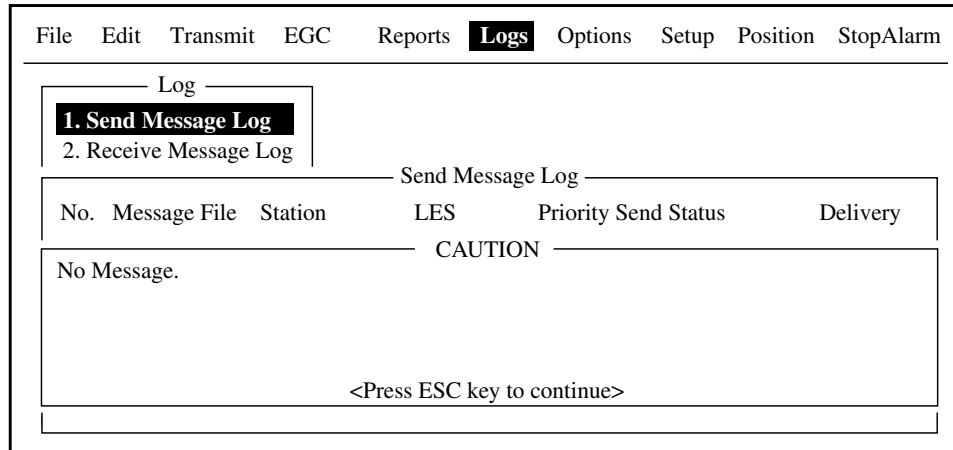

Location of error messages and alerts

1.6 Choosing a Printer

Choose the printer to use as follows:

1. Press the [F1] key to display the File menu.

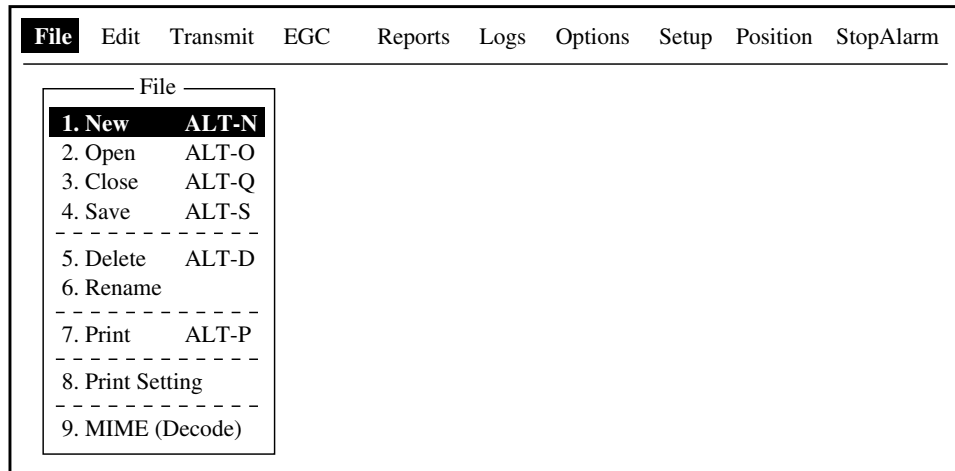

File menu

2. Press the [8] key to choose 8. Print Setting.

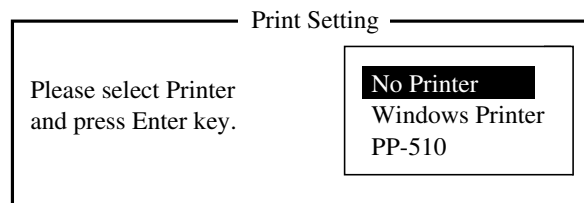

3. Press the [↑] or [↓] key to choose appropriate printer.
 No Printer: Choose this item if no printer is connected.
 Windows Printer: Choose if a PC-use printer is connected.
 PP-510: Choose if PP-510 is connected.
4. Press the [Esc] key to finish.

1. OPERATIONAL OVERVIEW

(This page intentionally left blank.)

2. SYSTEM INITIALIZATION

This chapter provides the information necessary for initializing the FELCOM 16. Once the equipment is initialized, you need do no more than press a few keys to transmit and receive.

Inmarsat assigns an MES an Inmarsat Mobile Number (IMN) when it applies for Inmarsat registration and it is entered during the installation of the MES. The IMN is necessary to communicate in the Inmarsat system.

2.1 System Settings

The System Setup menu provides for input of date, time, operating mode, and port function.

1. Press the [F8] key to choose the Setup menu.

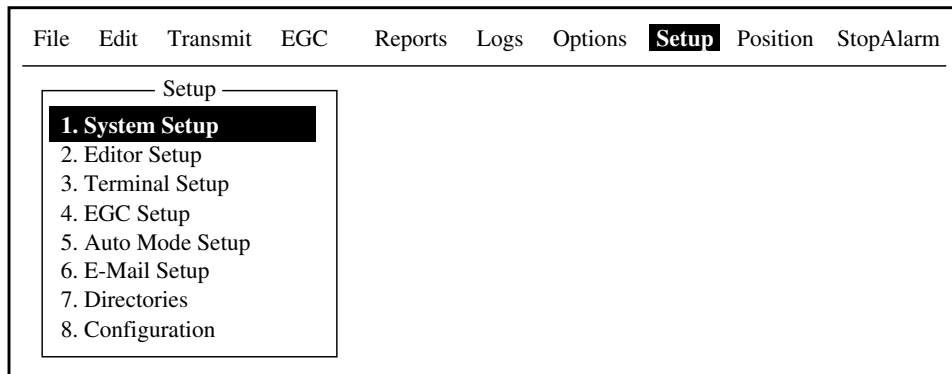

Setup menu

2. Press the [1] key to display the System Setup menu.

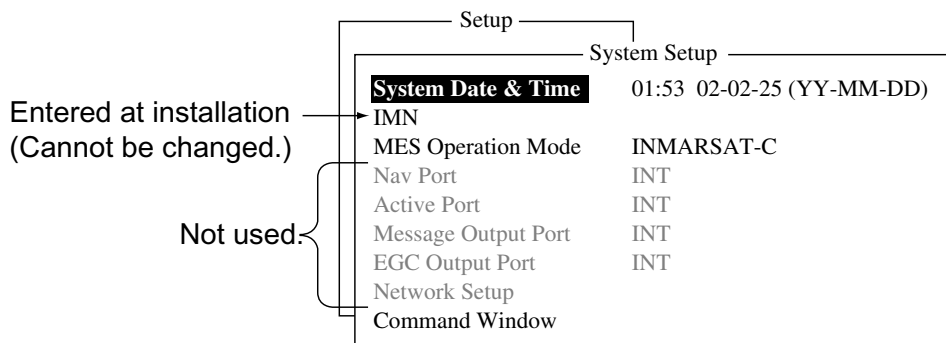

System setup menu

Note: The IMN number is entered during the installation. The number cannot be changed.

2. SYSTEM INITIALIZATION

- Press the [↓] key twice to choose MES Operation Mode.
- Press the [Enter] key to open the MES operation mode options window.

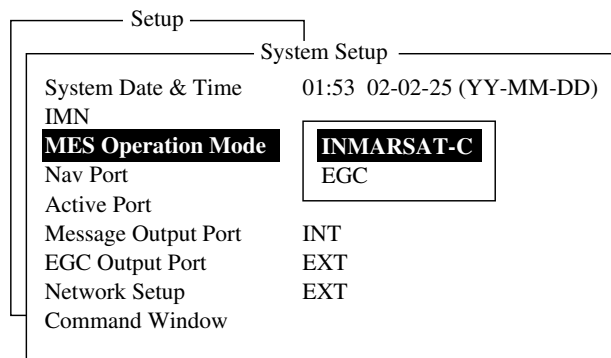

System setup menu, MES operation mode options window

- Press the [↓] or [↑] key to choose operating mode, INMARSAT-C or EGC. The INMARSAT-C setting provides telex communications and operates as an EGC receiver when the equipment is not transmitting or receiving. The EGC setting enables EGC-only operation. In this case, "Current State: EGC RECEIVER" (in reverse video) at the bottom of the screen.
- Press the [Enter] key to close the window.
- Press the [Esc] key to open the update window.

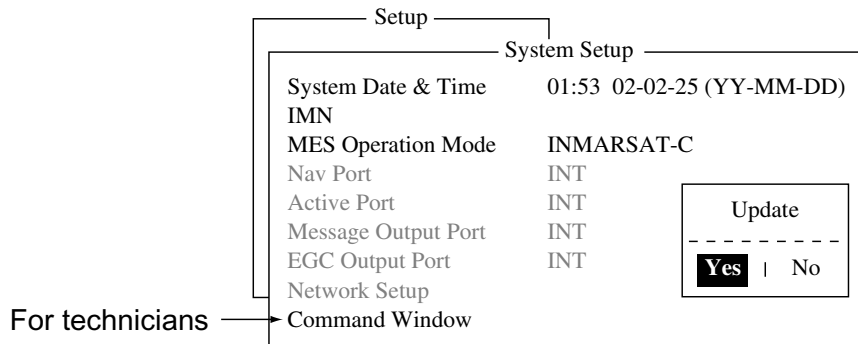

- Yes is selected; press the [Enter] key to update system settings.
- Press the [Esc] key to return to the standby display.

Note: If the internal GPS malfunctions, enter data manually as below.

- Choose System Date & Time from the System Setup menu and then press the [Enter] key.

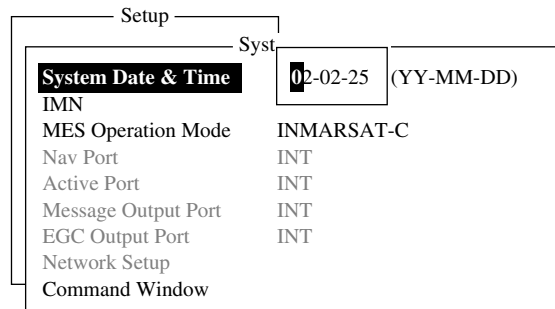

Date and time entry window

- Enter date with the numeric keys.
- Press the [Enter] key to close the window.

2.2 PC Window Setup

The Terminal Setup menu provides for set up of the PC window. Set up includes selection of date display format, currency unit and window colors.

1. Press the [F8] key to choose the Setup menu.
2. Press the [3] key to display the Terminal Setup screen.

Terminal Setup	
Date Disp. Form	YY-MM-DD
Currency Unit	US\$
Screen Saver	ON
Window Color	

Terminal Setup menu

3. Date Disp. Form is selected; press the [Enter] key to open its options window.

YY-MM-DD
MMM-DD-YY
DD-MMM-YY

Date options

4. Press the [↓] or [↑] key to choose date display format desired and then press the [Enter] key to close the window.
5. Press the [↓] key to choose Currency Unit.
6. Press the [Enter] key to open the currency unit options window.

SDR
US\$
EUR
YEN
OTHER

Currency unit options

7. Press the [↓] or [↑] key to choose the currency unit to use to calculate toll charges. SDR means Special Drawing Right and it is the common unit charge used by all LES to assess toll charges. For OTHER, enter currency unit name (4 characters max.). Your selection appears next to Currency Unit in the Terminal Setup menu.
8. Press the [Enter] key to close the window.
9. Press the [↓] key to choose Window Color and press the [Enter] key.

Window Color	
Window Color Setup	
Default Color	

Window color menu

2. SYSTEM INITIALIZATION

10. You may change the background and foreground colors for the various display screens on the PC window as follows:

a) Choose Window Color Setup.

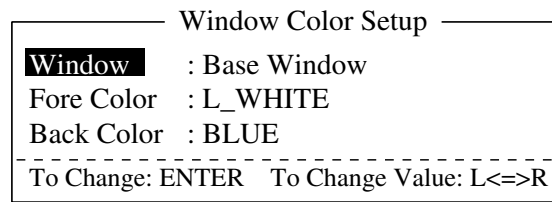

Window color setup menu

b) Window is selected; press the [→] or [←] key to choose the item to adjust.

BASE WINDOW:	Standby display
RCV Message Display:	Communications memory display
EGC Message Display:	Communications display
EDIT1 – EDIT 2	Editor screens
Function:	Menu
Sub Menu1 – Sub Menu4:	Sub menus
Message:	Status message

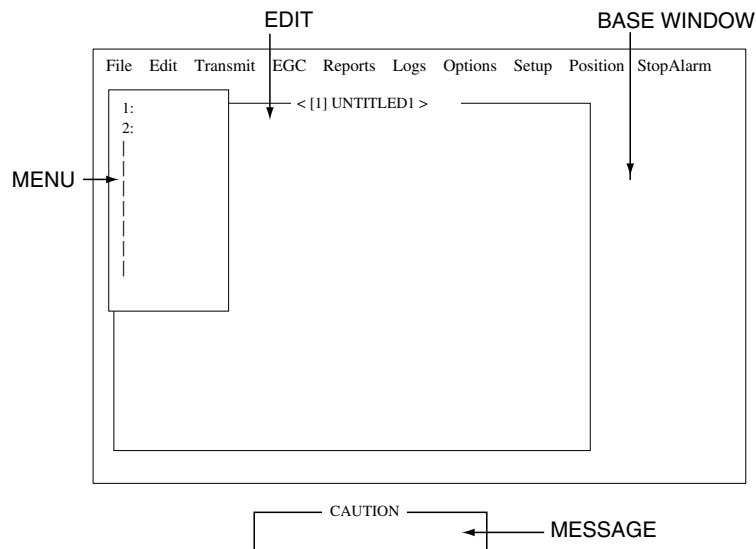

Location of items

- Press the [↓] key to choose Fore Color.
- Press the [→] or [←] key to choose foreground color desired
- Press the [↓] key to choose Back Color.
- Press the [→] or [←] key to choose background color.
- To change the color of other windows, repeat steps b-f.
- Finally press the [Enter] key to show the Update window.
- Yes is selected; press the [Enter] key.

Note: To restore all default color settings, choose Window Color from the Terminal Setup menu, choose Default Color and then press the [Enter] key. Yes is selected; press the [Enter] key.

11. Press the [Esc] key three times to return to the standby display.

2.3 Login and Logout

Each time the terminal unit is turned on, register your vessel with the Inmarsat C system to enable communications between your vessel and an LES. This is called login. The first time you login you must do it manually; thereafter it is done automatically, even when you move to another ocean region.

Note that you can transmit or receive EGC messages even if you are not logged in.

If you will not be using the FELCOM 16 for a prolonged period, you should logout from the Inmarsat C system, before turning off the terminal unit. The Inmarsat C system will then register you as inactive, notifying anyone trying to call you that you are currently unavailable. If you do not log out before turning off the power, some LESs may attempt to send a message to you. They may charge your correspondent, even if you don't receive the message.

2.3.1 Login

1. Confirm that "SYNC (NCS)" appears at the bottom of the screen.
2. Press the [F7] key to display the Options menu.

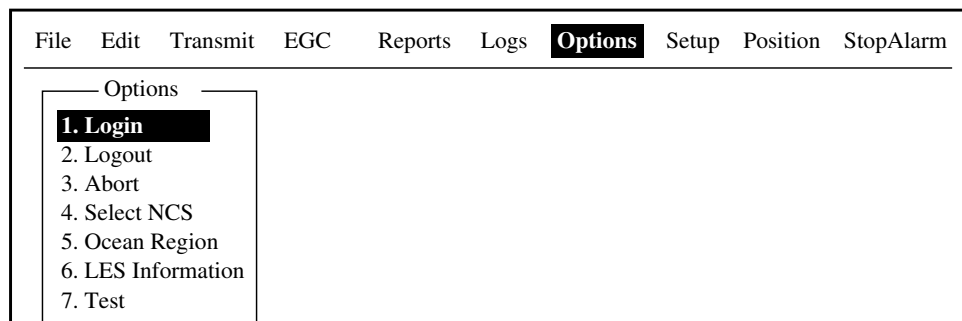

Options menu

3. Press the [1] key to display the Login screen.

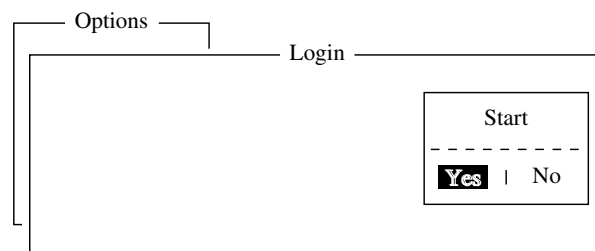

Login screen

2. SYSTEM INITIALIZATION

Note: The terminal unit must be “idle” to login. (“Current State: IDLE” appears at the bottom of the screen.) When it is not idle, “Ignored: MES is not idle.” appears. Press the [Esc] key to return to the standby display. Wait until the terminal unit becomes idle.

4. Yes is selected; press the [Enter] key to start login.
5. Login begins and the screen should now look something like the illustration below, with “LOGIN” flashing.

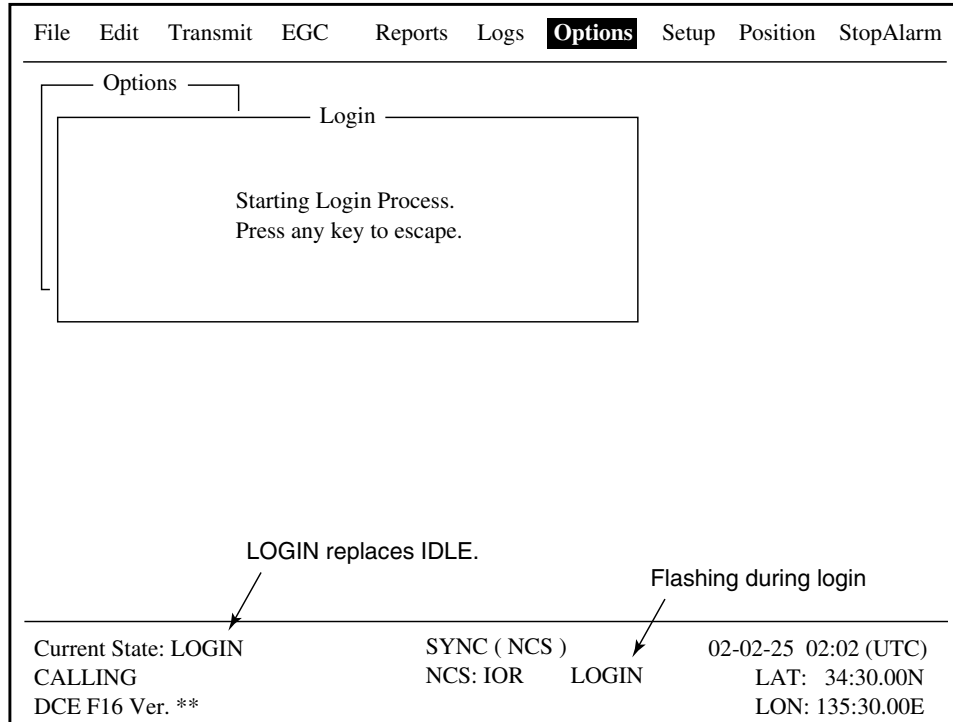

Appearance of display screen during login

When login is completed, the message “Successful login.” appears. Then, the terminal unit goes into “Idle” status and LOGIN stops blinking.

6. Press any key to return to the standby display.

2.3.2 Logout

1. Press the [F7] key to display the Options menu.
2. Press the [2] key to display the logout screen.

Note: The terminal unit must be “idle” to logout. When it is not idle, “Ignored: MES is not idle.” appears. Press the [Esc] key to return to the standby display. Wait until the terminal unit becomes idle.

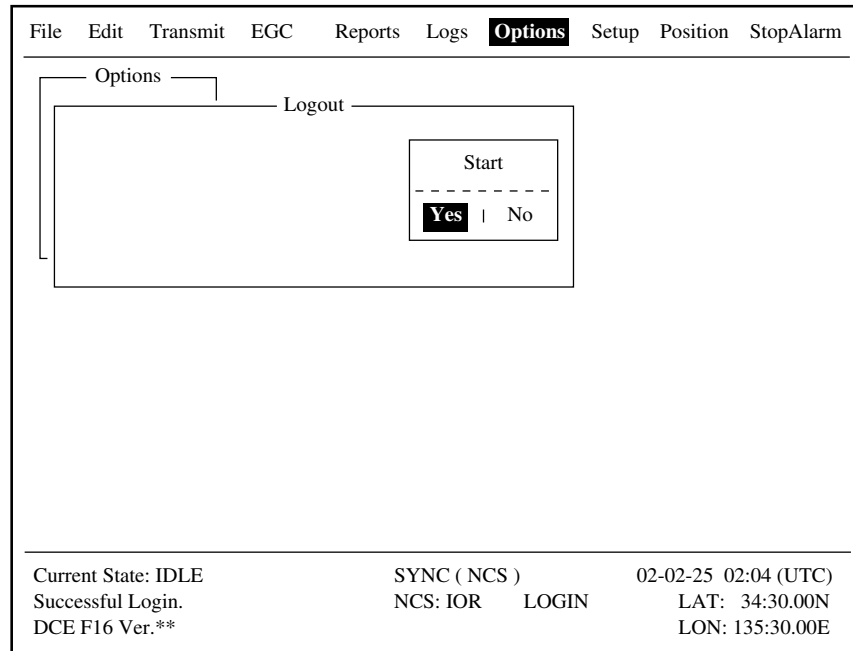

Options menu, logout screen

3. Yes is selected; press the [Enter] key to start logout. The screen now looks something like the illustration below.

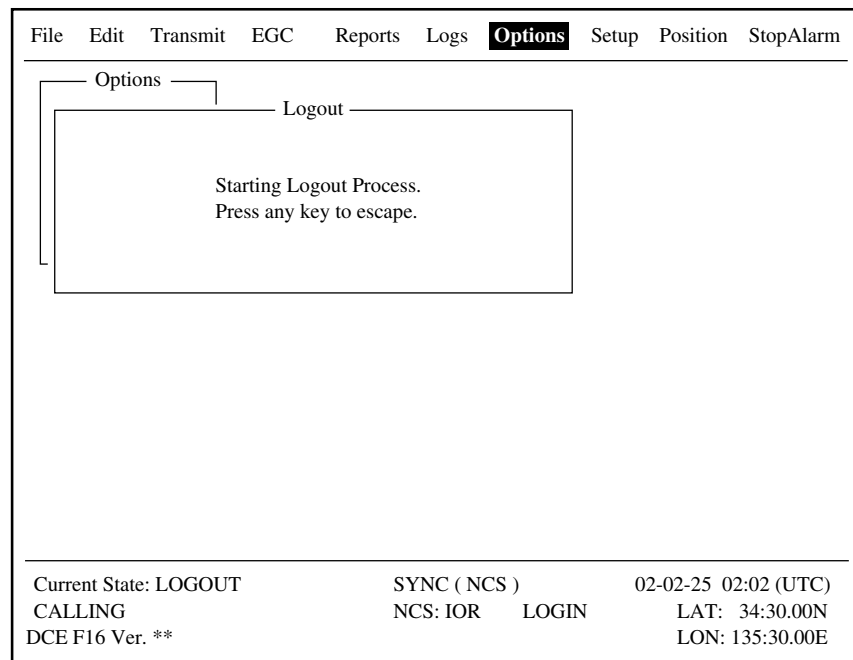

Appearance of display screen during logout

4. When logout is completed, “Successful Logout.” appears. “Current State” then returns to IDLE.
5. Turn off the FELCOM 16.

2.4 EGC Settings

2.4.1 What is the EGC (Enhanced Group Call) service?

The EGC service enables EGC information providers to send SafetyNET™, FleetNET™ and System messages via an LES to a specific groups of ships, or to all ships within a defined geographical area.

Each type of EGC service is sent as follows:

- 1) The information provider prepares the message, and then accesses the appropriate Country of the international telex network to send the message to an LES.
- 2) The LES processes and forwards it to the NCS for the ocean region designated by the provider.
- 3) Then, the NCS broadcasts the message throughout the ocean region. (The operator may choose the EGC messages to receive by position (one position) and geographical position (nine areas). For further details see paragraph 2.4.2.)

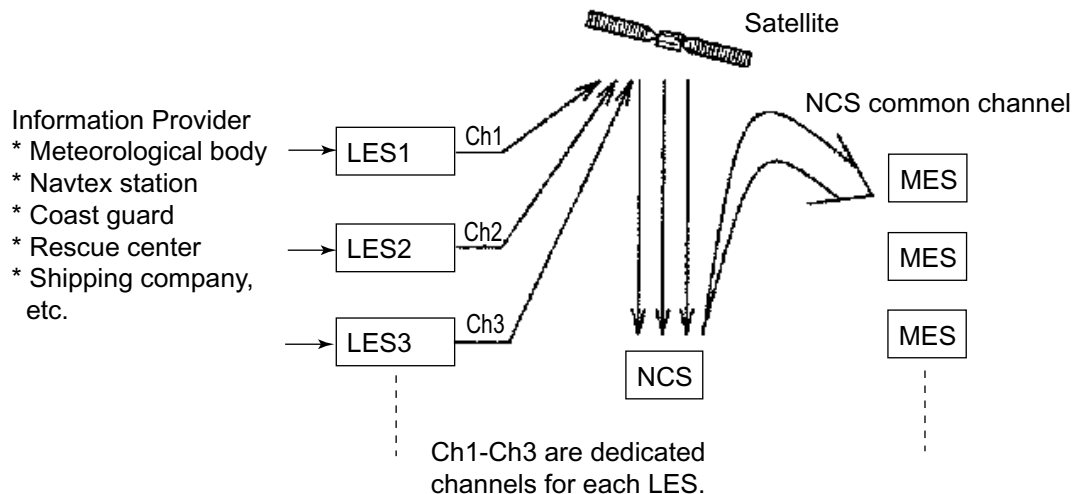

The EGC system

Three EGC services are available:

1) SafetyNET™

This provides a means for information providers to distribute Maritime Safety Information (MSI) from shore-to-ship. Authorized information providers include:

- a) Hydrographic Offices, for navigational warnings
- b) National Weather Services, for meteorological warnings and forecasts
- c) Rescue Co-ordination Center, for shore-to-ship distress alerts and other urgent information
- d) International Ice Patrol, for North Atlantic ice hazards

2) FleetNET™

This service allows authorized information providers such as commercial subscription services, shipping companies and governments, which have registered with a LES that supports FleetNET™, to broadcast messages to selected group of MESs. Typical applications of FleetNET™ are

- a) Fleet or company broadcasts
- b) News broadcasts
- c) Commercial weather services
- d) Market quotations
- e) Government broadcasts to all vessels on a country's registration

3) System

EGC system-related is sent by Inmarsat to certain ship groups and geographical areas.

2.4.2 EGC setup

The FELCOM 16 receives EGC messages directed to its present position and Navarea without further programming. The EGC Setup screen lets you choose additional areas for which to receive messages and also the Navtex station and type of message for Coastal Warning (NAVTEX Re-broadcast).

1. Press the [F8] key to display the Setup menu.

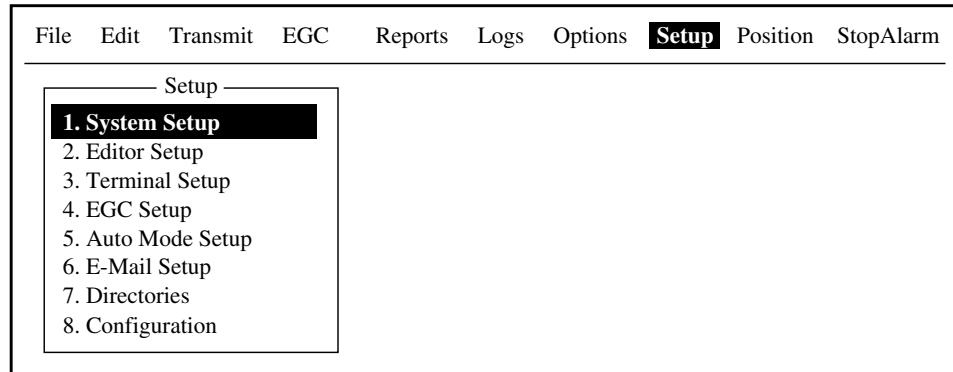

Setup menu

2. Press the [4] key to display the EGC Setup menu.

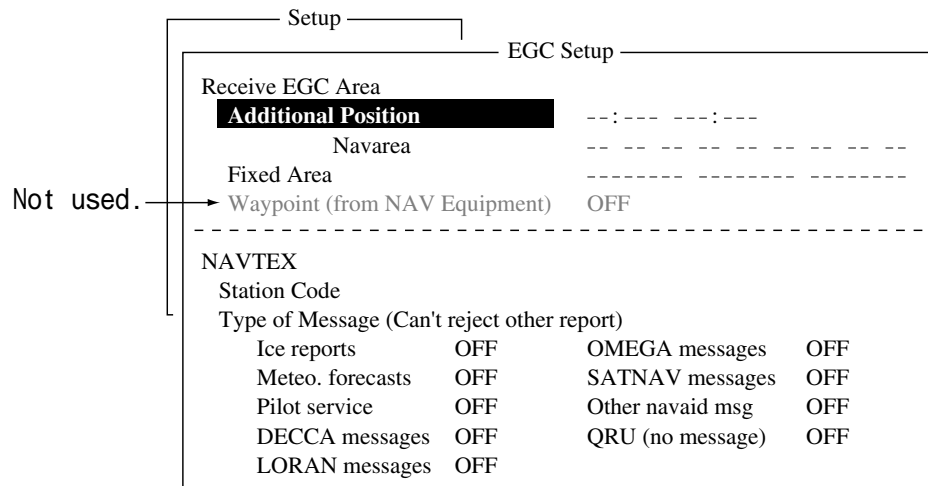

EGC setup menu

3. The cursor is selecting Additional Position, where you can enter the L/L position of an ocean region you want to receive broadcasts about. Press the [Enter] key to open the additional position entry window.
4. Enter position as follows:
 - a) Enter latitude (XX° XX).
 - b) Press the [N] or [S] key as appropriate to enter coordinate.
 - c) Enter longitude (XXX° XX).
 - d) Press the [E] or [W] key as appropriate enter coordinate.
5. Press the [Enter] key to close the additional position entry window.
6. Press the [↓] key to choose Navarea.

7. Press the [Enter] key to open the navarea entry window.

Setup

EGC Setup

Receive EGC Area

Additional Position
Navarea -----

Fixed Area

Waypoint (from NAV Equipment) OFF

NAVTEX

Station Code

Type of Message (Can't reject other report)

Ice reports	OFF	OMEGA messages	OFF
Meteo. forecasts	OFF	SATNAV messages	OFF
Pilot service	OFF	Other navaid msg	OFF
DECCA messages	OFF	QRU (no message)	OFF
LORAN messages	OFF		

EGC setup menu, Navarea entry window

8. Enter additional Navarea(s) (I-XVI, up to nine) in two digits, referring to the illustration below for code number.

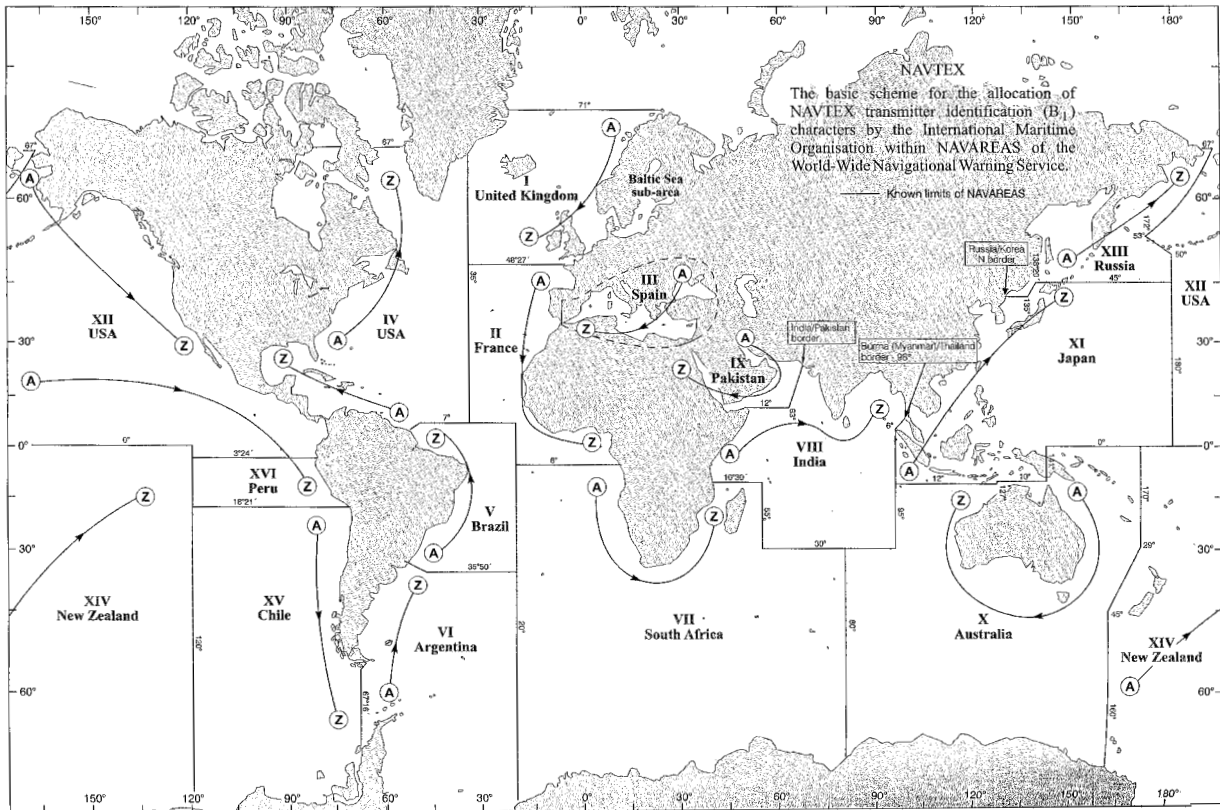

Navareas

9. Press the [Enter] key to close the navarea entry window.

Note: “Fixed Area” is where you enter fixed areas (max. 3) for chart correction service. However, this service is not yet available; enter no data.

2. SYSTEM INITIALIZATION

10. Press the [↓] key to choose Station Code.

11. Press the [Enter] key to open the station code entry window.

The screenshot shows the 'EGC Setup' menu. At the top, 'Receive EGC Area' is selected. Below it are 'Additional Position', 'Navarea', 'Fixed Area', and 'Waypoint (from NAV Equipment) OFF'. A dashed line separates this from the 'NAVTEX' section. Under 'NAVTEX', 'Station Code' is highlighted with a cursor. Below it is the text 'Type of Message (Can't reject other report)' followed by a list of message types and their status (OFF):

Ice reports	OFF	OMEGA messages	OFF
Meteo. forecasts	OFF	SATNAV messages	OFF
Pilot service	OFF	Other navaid msg	OFF
DECCA messages	OFF	QRU (no message)	OFF
LORAN messages	OFF		

EGC setup menu, station code entry window

12. Enter the navtex station code (A-Z) of the navarea, in upper case alphabet.

For details about navtex stations, consult the operator's manual of the navtex receiver.

13. Press the [Enter] key to close the station code entry window.

14. Choose message type to receive:

- Press the [↓] or [↑] key to choose message type.
- Press the [Enter] key.
- Press the [↓] or [↑] key to choose ON or OFF as appropriate.
- Repeat a) thru c) to set other message types.
- Press the [Enter] key.

Note: Navtex messages "Coastal navigational information", "Meteorological warning" and "Search and rescue alert" (they do not appear on the EGC Setup menu) must always be received.

15. Press the [Esc] key to open the update window.

The screenshot shows the 'EGC Setup' menu. The 'Station Code' field is now filled with a cursor. Below the message type list, an 'Update' window is open with 'Yes' selected:

Ice reports	OFF	OMEGA message	
Meteo. forecasts	OFF	SATNAV message	
Pilot service	OFF	Other navaid msg	
DECCA messages	OFF	QRU (no message)	
LORAN messages	OFF		

Update
Yes | No

EGC setup menu, update window

16. Yes is selected; press the [Enter] key to update EGC settings.

17. Press the [Esc] key to return to the standby display.

2.4.3 Adding EGC channels

The EGC Channel List stores EGC channels. There are currently four EGC channels, one for each satellite. These four channels are pre-programmed into the unit and marked in the EGC Channel List with asterisks. When more EGC channels become available you can add them to the list as below.

1. Press the [F8] key to display the Setup menu.
2. Press the [8] key to display the Configuration menu.
3. Press the [3] key to display the EGC Channel List.

File	Edit	Transmit	EGC	Reports	Logs	Options	Setup	Position	StopAlarm
Setup									
Configuration									
EGC Channel List									
ENTER: Set ESC: Quit									
-----+-----+-----+-----+-----									
11080* 12580* 10840* 11088*									

EGC channel list

4. Using the arrow keys, place the cursor where there is no data entered. Current EGC channels are marked with an asterisk. These channels cannot be changed.

2. SYSTEM INITIALIZATION

5. Press the [Enter] key to open the EGC channel list entry screen.

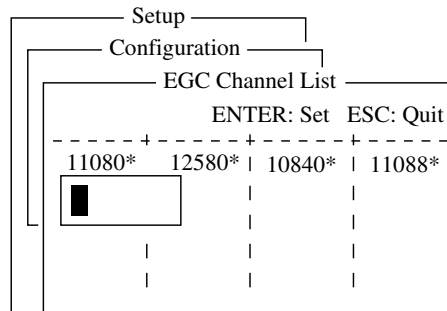

EGC channel list entry screen

6. Enter EGC channel frequency code. The EGC channel frequency code range is 6000-14000.
7. Press the [Enter] key to close the text window.
8. Press the [Esc] key to open the update window.

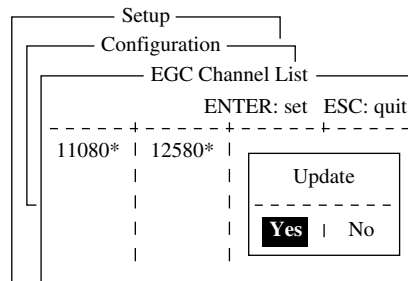

EGC channel list, update window

9. Yes is selected; press the [Enter] key to register input.

Note: If the EGC channel frequency code entered is invalid, the message "Input Error: Channel No." appears. Clear the error message by pressing the [Esc] key. Place the cursor at the invalid frequency, press the [Enter] key and enter correct frequency.

10. Press the [Esc] key twice to return to the standby display.

2.4.4 Saving, printing EGC messages automatically

You may choose the EGC messages to save and print as follows:

Automatically saving EGC messages

1. Press the [F8] key to display the Setup menu.
2. Press the [5] key to display the Auto Mode Setup menu.

Auto Mode Setup	
Auto Log Print	OFF
Receive Alarm	OFF
Auto Receive Message Save	OFF
Auto Receive Message Print	OFF
Data Report & Polling Print	OFF
Auto EGC Message Save	
Auto EGC Message Print	

Auto EGC message save menu

3. Press the [↓] or [↑] key to choose Auto EGC Message Save and then press the [Enter] key.

Auto Mode Setup	
Auto EGC Message Save	
System	OFF
FleetNET	OFF
SafetyNET (Routine)	OFF
SafetyNET (Safety)	OFF
SafetyNET (Urgent & Distress)	ON

Auto EGC message print menu

4. Press the [↓] or [↑] key to choose message type and then press the [Enter] key.
5. Choose ON or OFF as appropriate and press the [Enter] key to close the window.
6. Press the [Esc] key three times to return to the standby display.

Automatically printing EGC messages

1. Press the [F8] key to display the Setup menu.
2. Press the [5] key to display the Auto mode setup menu.
3. Press the [↓] key to choose Auto EGC Message Print and then press the [Enter] key.

Auto Mode Setup	
Auto EGC Message Print	
System	OFF
FleetNET	OFF
SafetyNET (Routine)	OFF
SafetyNET (Safety)	OFF
SafetyNET (Urgent & Distress)	OFF

Auto EGC message print menu

4. Press the [↓] or [↑] key to choose message type and then press the [Enter] key.
5. Choose ON or OFF as appropriate and press the [Enter] key to close the window.
6. Press the [Esc] key three times to return to the standby display.

2.5 Adding NCS Channels

This section shows you how to add NCS channels to the NCS Channel List. 19 channels can be listed per each ocean region. Currently, there are four NCS channels, and they are marked with asterisks in the list. Add NCS channels to the list as below when they become operational.

1. Press the [F8] key to display the Setup menu.
2. Press the [8] key to display the Configuration menu.
3. Press the [4] key to display the NCS Channel List.

NCS Channel List									
ENTER: Set ESC: Quit									
No	AOR (WEST)		AOR (EAST)		POR		IOR		
	ID	FREQ	ID	FREQ	ID	FREQ	ID	FREQ	
1	044	11080*	144	12580*	244	12580*	344	10840*	
2	0		1		2		3		
3	0		1		2		3		
4	0		1		2		3		
5	0		1		2		3		
6	0		1		2		3		
7	0		1		2		3		
8	0		1		2		3		

NCS channel list

4. Use the arrow keys to place the cursor in a blank ID column.
5. Press the [Enter] key to open the data entry window.
6. Enter NCS channel ID number, in two digits. (Entry of leading zero is not necessary.) The ID number range is 45-63.
7. Press the [Enter] key to close the window.
8. With the [→] key, choose the frequency column.
9. Press the [Enter] key to open the frequency entry window.
10. Enter NCS channel frequency code. The frequency code range is 6000-14000.
11. Press the [Enter] key to close the window.
12. Press the [Esc] key to open the update window.

NCS Channel List									
ENTER: Set ESC: Quit									
No	AOR (WEST)		AOR (EAST)		POR		IOR		
	ID	FREQ	ID	FREQ	ID	FREQ	ID	FREQ	
1	044	11080*	144	12580*	244	12580*	344	10840*	
2	0		1		2		3		
3	0		1		2		3		
4	0		1		2				
5	0		1		2				
6	0		1		2				
7	0		1		2				
8	0		1		2				

Update

Yes | No

NCS channel list, update window

2. SYSTEM INITIALIZATION

13. Yes is selected; press the [Enter] key to register input.

Note: If the ID or frequency entered is invalid the message "Input Error: NCS ID" (for invalid ID) or "Input Error: Channel No." (for invalid frequency) appears. Clear the error message by pressing the [Esc] key. Place the cursor at the invalid ID or frequency code. Then, press the [Enter] key and enter correct ID or frequency.

14. Press the [Esc] key twice to return to the standby display.

2.6 LES List

The LES List provides for storage of 44 LES names per ocean region. By entering approximate toll charges in the LES list, you can see that information on the Transmit message menu.

2.6.1 Setting toll charges

Main LES (LES name and ID) are already registered in the FELCOM 16; but, toll charges are not set. To set communication toll charges do the following:

1. Press the [F8] key to display the Setup menu

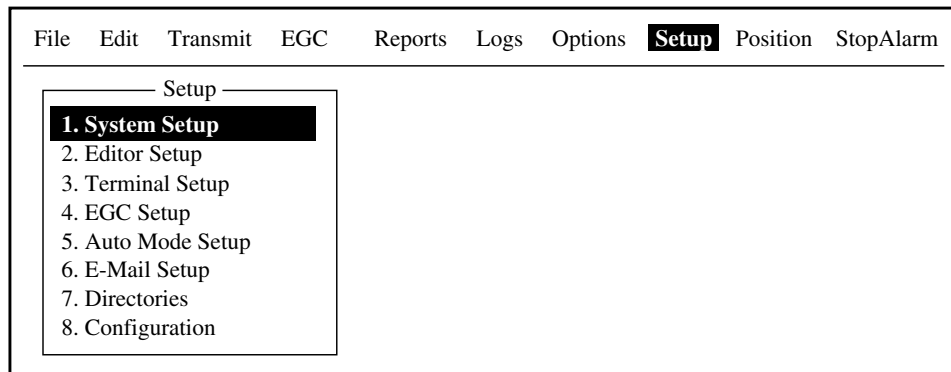

Setup menu

2. Press the [8] key to display the Configuration menu.

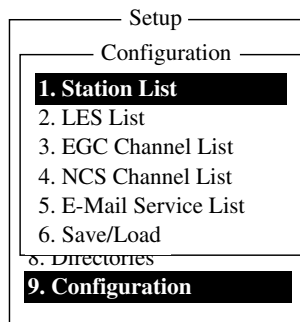

Configuration menu

2. SYSTEM INITIALIZATION

3. Press the [2] key to display the LES List.

LES List				
Ctrl+P: Print ENTER: List Entry ESC: Quit				
No	AOR (WEST) Name	AOR (EAST) Name	POR Name	IOR Name
01	Telenor S.S.Inc	Telenor S.S.Inc	Telenor S.S.Inc	
02	Stratos M.N.	Stratos M.N.	Stratos M.N.	Stratos M.N.
03	KDDI	KDDI	KDDI	KDDI
04	Telenor S.S.AS	Telenor S.S.AS	Telenor S.S.AS	Telenor S.S.AS
05		Telecom Italia		OTE
06				VSNL
07				
08			Korea Telecom	Korea Telecom

LES list

- Using the arrow keys, choose the LES for which you want to enter toll charges. For example, choose KDDI (Japan).
- Press the [Enter] key.

Setup
LES List

Configuration
Ctrl+P: Print ENTER: List Entry ESC: Quit

No	AOR (WEST) Name	AOR (EAST) Name	POR Name	IOR Name
01	Telenor S.S.Inc	Telenor S.S.Inc	Telenor S.S.Inc	
02	Stratos M.N.	Stratos M.N.	Stratos M.N.	Stratos M.N.
03	KDDI	KDDI	KDDI	KDDI
04	Telenor S.S.AS	Telenor S.S.AS	Telenor S.S.AS	Telenor S.S.AS
05		Telecom Italia		OTE
06				VSNL
07				
08			Korea Telecom	Korea Telecom

Name : KDDI
ID : 303
Remarks : JAPAN
Charge (US\$/256bit)
 TELEX *****
 FAX *****
 E-Mail *****
 CSDN *****
 PSDN *****
 X400 *****
 DNID *****
 SPEC *****

 Erase the Name to delete this LES.

LES list, LES data entry window

- Press the [↓] key to choose TELEX and press the [Enter] key to open the text entry window.
- Enter telex charges (per 256 bit) and press the [Enter] key.
For toll charges, contact appropriate LES.
- Enter toll charges for other items similarly.
- Press the [Esc] key to return to the LES list.
- Press the [Esc] key three times to return to the standby display.

2.6.2 Registering LES to LES list

Follow the procedure below to register newly constructed LESs.

1. Press the [F8], [8] and [2] keys to show the LES list.
2. Use the arrow keys to place the cursor where desired. For example, choose 005 in the AOR(WEST) column.

Setup
Configuration

LES List

Ctrl+P: Print ENTER: List Entry ESC: Quit

No	AOR (WEST) Name	AOR (EAST) Name	POR Name	IOR Name
01	Telenor S.S.Inc	Telenor S.S.Inc	Telenor S.S.Inc	
02	Stratos M.N.	Stratos M.N.	Stratos M.N.	Stratos M.N.
03	KDDI	KDDI	KDDI	KDDI
04	Telenor S.S.AS	Telenor S.S.AS	Telenor S.S.AS	Telenor S.S.AS
05	[Black Box]	Telecom Italia	Telenor S.S.AS	OTE
06				VSNL
07				
08			Korea Telecom	Korea Telecom

Place cursor here.

LES ID: XXX
 ↑
 No. (00-43)
 0: AOR(WEST)
 1: AOR(EAST)
 2: POR
 3: IOR

Configuration menu

3. Press the [Enter] key.

Setup
Configuration

LES List

Ctrl+P: Print ENTER: List Entry ESC: Quit

No	AOR (WEST) Name	AOR (EAST) Name	POR Name	IOR Name
01	Telenor S.S.Inc	Telenor S.S.Inc	Telenor S.S.Inc	
02	Stratos M.N.	Stratos M.N.	Stratos M.N.	Stratos M.N.
03	KDDI	KDDI	KDDI	KDDI
04	Telenor S.S.AS	Telenor S.S.AS	Telenor S.S.AS	Telenor S.S.AS
05				OTE
06				VSNL
07				
08			Korea Telecom	Korea Telecom

Name :

ID : 005

Remarks :

Charge (US\$/256bit)

TELEX *****

FAX *****

E-Mail *****

CSDN *****

PSDN *****

X400 *****

DNID *****

SPEC *****

Erase the Name to delete this LES.

LES list options

4. Name is selected; press the [Enter] key to open the text entry window.

2. SYSTEM INITIALIZATION

Name	:	<input type="text"/>
ID	:	<input type="text"/>
Remarks	:	
Charge	:	(US\$/256bit)
TELEX	:	***** **
FAX	:	***** **
E-Mail	:	***** **
CSDN	:	***** **
PSDN	:	***** **
X400	:	***** **
DNID	:	***** **
SPEC	:	***** **

Erase the Name to delete this LES.		

LES list, text entry window

5. Enter LES name (maximum 15 characters).
6. Press the [Enter] key.
7. Press the [↓] key twice to choose Remarks.
8. Press the [Enter] key.
9. Enter remarks (up to 20 characters).
10. Press the [Enter] key.
11. Press the [↓] key to choose TELEX and press the [Enter] key.
12. Enter TELEX toll charges (per 256 bit) and press the [Enter] key.
13. Enter toll charges for other items similarly.
14. Press the [Esc] key to return to the LES list.
15. Repeat steps 2-14 to enter another LES.
16. Press the [Esc] key three times to return to the standby display.

2.6.3 Editing the LES list

1. Press the [F8], [8] and [2] keys to shown the LES list.
2. Use the arrow keys to choose the LES you want to edit.
3. Press the [Enter] key.
4. Do the following:
 - Change station name:** Press the [↓] or [↑] key to choose Name and then press the [Enter] key. Press the [Backspace] key to erase name and then enter new name. Press the [Enter] key.
 - Delete station:** Press the [↓] or [↑] key to choose Name and then press the [Enter] key. Press the [Backspace] key to erase name and then press the [Enter] key.
5. Press the [Esc] key to quit.
6. Press the [Esc] key three times to return to the standby display.

2.6.4 Printing the LES list

1. Press [F8], [8] and [2] to display the LES list.
2. To print the LES list, press the [P] key while pressing the [Ctrl] key.

```
LES List ( Printed at 02-02-25 02:33 )

+++++ AOR (WEST) +++++
No.  Name                LES ID  Remarks
01   Telenor S.S.Inc      001    USA
02   Stratos M.N.        002    CANADA
03   KDDI                 003    JAPAN
04   Telenor S.S.AS      004    NORWAY
12   Xantic (NED)        012    NETHERLANDS
21   France Telecom      021    FRANCE
22   Xantic (AUS)        022    AUSTRALIA

+++++ AOR (EAST) +++++
No.  Name                LES ID  Remarks
01   Telenor S.S.Inc      101    USA
```

Sample LES list printout

3. To return to the standby display, press the [Esc] key three times.

TELEX	
FAX	
E-Mail	
CSDN	
PSDN	
X400	
DNID	
SPEC	
TELEX	(Prefixed)
FAX	(Prefixed)
PSDN	(Prefixed)
X400	(Prefixed)
DNID	(Prefixed)
SPEC	(Prefixed)

Destination (communication) type options

TELEX: Telex communication

FAX: Facsimile service

E-Mail: E-mail (electronic mail) Service

CSDN: Circuit Switched Data Network-not used.

PSDN: Packet Switched Data Network

- to an office computer via a data network using X.25 standard.

X400: For future use

DNID: Data Network ID. See page 5-12.

SPEC: Ship-to shore requests for safety service, accessed by using special code numbers

15. Press the [↓] or [↑] key to choose destination type desired.

16. Press the [Enter] key to close the window. Follow appropriate procedure on the next several pages.

Procedure for Telex

1. Press the [↓] key to choose Country Code.

2. Press the [Enter] key.

3. For ship-to-shore telex, enter international telex country code; ship-to-ship telex, enter ocean region. A list of international telex country codes appears in the Appendix.

Ocean Region

AOR-East: 581 POR: 582

IOR: 583 AOR-West: 584

4. Press the [Enter] key.

5. Press the [↓] key to choose Station ID.

6. Press the [Enter] key to open the station ID entry window.

7. Enter telex subscriber number (for ship-to-shore) or MES Inmarsat Mobile Number (for ship-to-ship). Up to 15 characters, including space, can be entered.

8. Press the [Enter] key to close the window.

9. Press the [↓] key to choose Remarks.

10. Press [Enter] to open the remarks entry window.

11. Enter remarks, using up to 20 characters.

2. SYSTEM INITIALIZATION

12. Press the [Enter] key to close the window.
13. Press the [Esc] key to return to the station list.
14. To enter another "Telex" station repeat the procedure from step 4 on page 2-24.
15. Press the [Esc] key three times to return to the standby display.

Procedure for FAX

1. Press the [↓] key to choose Country Code.
2. Press the [Enter] key to open the country code entry window.
3. Enter international telephone code of subscriber. See the Appendix for list of telephone codes.
4. Press the [Enter] key to close the window.
5. Press the [↓] key to Station ID.
6. Press the [Enter] key to open the station ID entry window.
7. Enter fax number.
8. Press the [Enter] key to close the window.
9. Press the [↓] key to choose Modem Type.
10. Press the [Enter] key to open the modem type options window.

Modem Type		
T30	FAX	
V21	V.21	300bps Duplex
V22	V.22	1200bps Duplex
V22B	V.22bis	2400bps Duplex
V23	V.23	600/1200bps
V26B	V.26bis	2400/1200bps
V26T	V.26ter	2400bps Duplex
V27T	V.27ter	4800/2400bps
V32	V.32	9600bps Duplex
Other		

Modem type options window

11. Press the [↓] or [↑] key to choose mode type of subscriber. For a landline fax or a fax-equipped Inmarsat B MES, choose "T30 FAX."
12. Press the [Enter] key to close the window.
13. Press the [↓] to choose Remarks.
14. Press the [Enter] key.
15. Enter remarks, using up to 20 characters.
16. Press the [Enter] key to close the window.
17. Press the [Esc] key to return to the station list.
18. To enter another "Fax" station repeat the procedure from step 4 on page 2-24.
19. Press the [Esc] key three times to return to the standby display.

Procedure for E-mail

1. Press the [↓] key to choose E-mail Address.
2. Press the [Enter] key to open the e-mail address entry window.
3. Enter recipient's e-mail address.
4. Press the [Enter] key to close the window.
5. Press the [↓] to choose Remarks.
6. Press the [Enter] key.
7. Enter remarks, using up to 20 characters.
8. Press the [Enter] key to close the window.
9. Press the [Esc] key to return to the station list.
10. To enter another "E-mail" station repeat the procedure from step 4 on page 2-24.
11. Press the [Esc] key three times to return to the standby display.

2.7.3 Printing the station list

1. Press [F8], [8] and [1] to display the Station List.
2. press the [P] key while pressing the [Ctrl] key.

```

-----
Station List ( Printed at 02-02-25 02:38 )
No. Group Name      Type  Dest, ID, Modem / Address  Remarks
01  x1   abc           E-Mail abc@ furuno.co.jp
02  x2   xyz           E-Mail xyz@ furuno.co.jp
03  x3   Seagull       TELEX 584 463609999
-----

```

Station List (Printed at 02-02-25 02:38)

No.	Group Name	Type	Dest, ID, Modem / Address	Remarks
01	x1	abc	E-Mail abc@ furuno.co.jp	
02	x2	xyz	E-Mail xyz@ furuno.co.jp	
03	x3	Seagull	TELEX 584 463609999	

Group Name Station Name Country Code Subscriber's Number

Sample station list printout

3. Press the [Esc] key three times to return to the standby display.

2.8 Entering Own Ship's Position

When the internal GPS navigator is abnormal, manually enter position as below.

1. Press the [F9] key to display the Position menu.

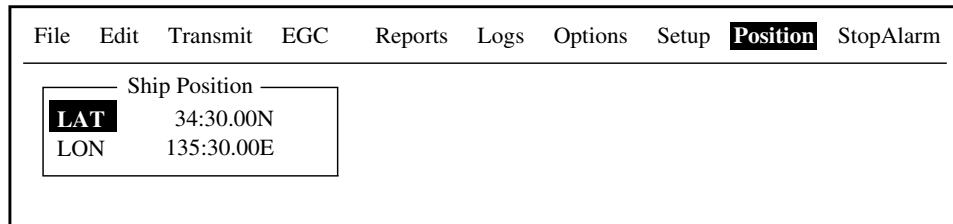

Ship position window

2. Press the [Enter] key to open the latitude entry window.

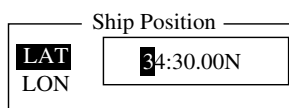

Latitude entry window

3. Enter latitude (XX° XX) and then press the [N] or [S] key as appropriate to enter coordinate.
4. Press the [Enter] key to close the window.
5. Press the [↓] key to choose LON.
6. Press the [Enter] key to open the longitude entry window.

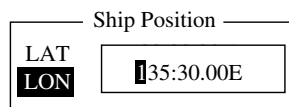

Longitude entry window

7. Enter longitude (XXX° XX) and then press the [E] or [W] key as appropriate to enter coordinate.
8. Press the [Enter] key to close the window.
9. Press the [Esc] key to open the update window.

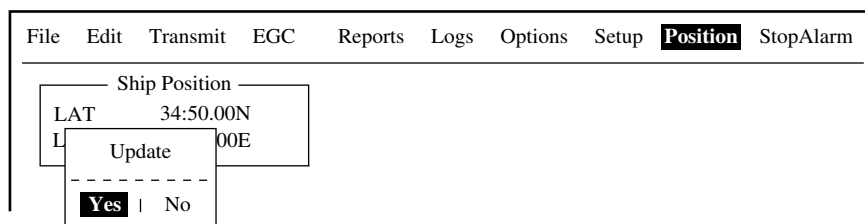

Ship position, update

10. Yes is selected; press the [Enter] key to update position and close the Ship Position menu. The position entered appears at the bottom right corner of the system status monitor screen.

2.9 Creating A Directory

Incoming and outgoing messages may be saved to the hard disk. If no directory is specified, all messages are saved to the root directory.

2.9.1 Creating a directory where to store messages

The procedure below shows how to create a directory on the root directory in the hard disk.

1. Press the [F8] key to display the Setup menu.
2. Press the [7] key to display the Directories menu.



Directories menu

3. Press the [↑] key to choose Message Directory and then press the [Enter] key.

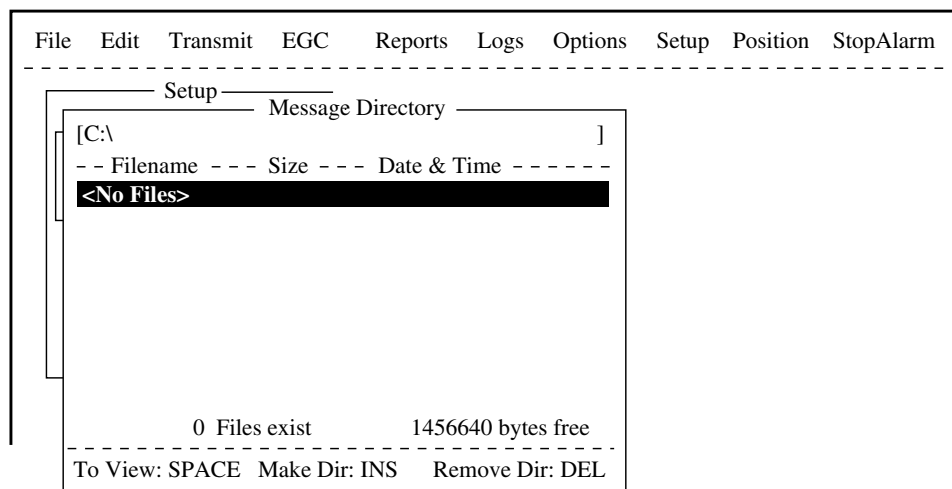

Setup menu, message directory

4. Press the [Insert] key.



Directory name entry window

2. SYSTEM INITIALIZATION

5. Enter directory name and press the [Enter] key. Entered name appears.

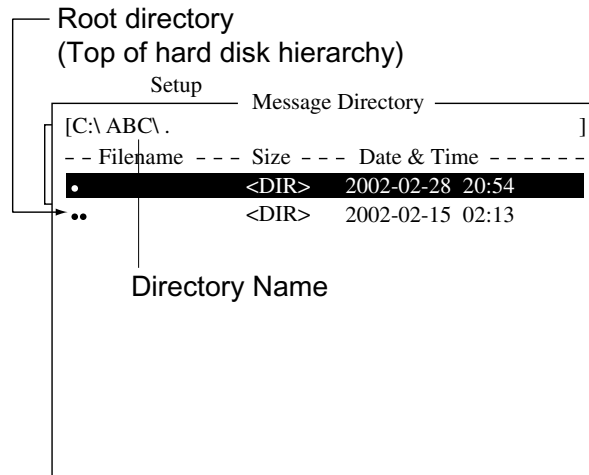

Message directory

- Note 1:** To create a directory within a directory at step 5, repeat steps 4 and 5.
- Note 2:** To return to the above stage, place the cursor on [..] and then press the [Enter] key.
6. Press the [Esc] key to show the Update window.
 7. Yes is selected; press the [Enter] key.
 8. Press the [Esc] key twice to return to the standby display. Then, received messages (transmitted messages) are saved to the directory created above.
- Note 1:** To remove a directory, do steps 1-3 in the above procedure, choose the directory to remove and then press the [Delete] key.
- Note 2:** A directory for EGC messages can also be made as above. In this case choose EGC Message Directory at step 3.

2.9.2 Specifying directory where to store messages

You may specify the directory where to store messages on the hard disk as follows:

1. Press the [F8] and [7] keys to show the Directories menu.
2. Press the [↑] key to choose Message Directory and press the [Enter] key.

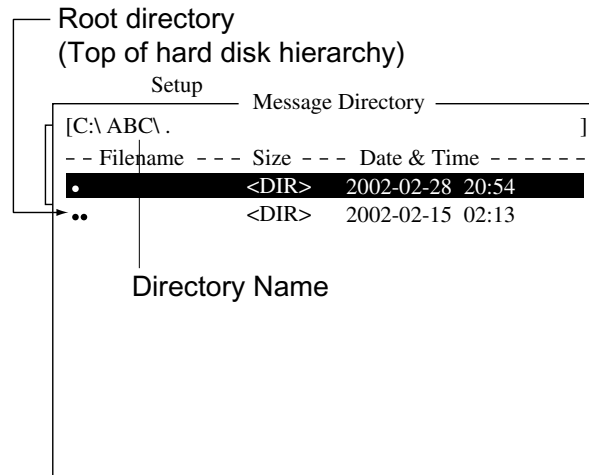

Message directory

3. Press the [↓] key to place the cursor on [••].
4. Press the [Enter] key. Root directory is displayed.
5. Press the [↓] or [↑] key to choose a directory.
6. Press the [Enter] key.
7. Press the [Esc] key to show the Update window.
8. Yes is selected; press the [Enter] key.
9. Press the [Esc] key twice to return to the standby display.

Note: The directory where to store EGC messages can also be created as above. Choose EGC Message Directory at step 2 in the above procedure.

2.10 E-mail Service List

The E-mail service list provides for e-mail service provider set up. E-mail service providers are already registered in the FELCOM 16. To add new e-mail service providers follow the procedure below.

1. Press the [F8] key to display the Setup menu.
2. Press the [8] key to display the Configuration menu.

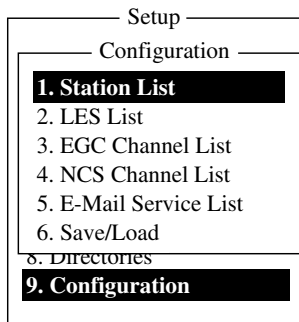

Setup menu, configuration

3. Press the [5] key to display the E-mail Service List.

	LES Name	AOR.W	AOR.E	POR	IOR
01	Telenor S.S.Inc	001	101	201	321
02	Xantic (NED)	012	112	212	312
03	Stratos M.N.	002	102	202	302
04	Telenor S.S.AS	004	104		304
05	KDDI	003	103	203	303
06	Singapore T.			210	328
07					
08					

Setup menu, E-mail service list

- Press the [↓] to choose a blank line in the Station Name column and then press the [Enter] key.

Service LES Name	
Service ID	
LES ID(AORW)	
(AORE)	
(POR)	
(IOR)	
To:	
Cc:	
Subject:	
Separator	
Attach File(MIME)	OFF

Enter data for LES which offers e-mail services. For details contact LES directly.

Example

Enter data of the KDDI LES (Japan) as follows:

Service LES Name	KDDI
Service ID	28
LES ID (AORW)	003
(AORE)	103
(POR)	203
(IOR)	303
To:	TO:
Cc:	CC:
Subject:	SUBJECT:
Separator	Blank
Attach File(MIME)	ON(UUENCODE)

E-mail setup items

- Press the [Enter] key to open the service LES name entry window.

Service LES Name	
Service ID	
LES ID(AORW)	
(AORE)	
(POR)	
(IOR)	
To:	
Cc:	
Subject:	
Separator	
Attach File(MIME)	OFF

Service station list, service station name entry window

- Type in LES which provides e-mail service.
- Press the [Enter] key to close the window.
- Press the [↓] key to choose Service ID.
- Press the [Enter] key to open the service ID entry window.
- Type in Service ID.
- Press the [Enter] key to close the window.
- Press the [↓] key to choose LES ID.
- Press the [Enter] key to open the LES ID entry window.
- Type LES ID of AOR-W.
- Press the [Enter] key to close the window.
- Enter LES ID for AOR-E, POR and IOR.
- Press the [↓] key to choose "To:".
- Press the [Enter] key to open the "to" header entry window.

2. SYSTEM INITIALIZATION

19. Type appropriate "To" header (for example, TO:, to+, etc.).
20. Press the [Enter] key to close the window.
21. Press the [↓] key to choose "Cc:."
22. Press the [Enter] key to open the "cc" header entry window.
23. Type appropriate "Cc" header (for example, CC:, cc+, etc.).
24. Press the [Enter] key to close the window.
25. Press the [↓] key to choose "Subject:."
26. Press the [Enter] key to open the subject entry window.
27. Type appropriate Subject header (for example, Subject:, subject+, etc.).
28. Press the [Enter] key to close the window.
29. Press the [↓] key to choose "Separator."
30. Press the [Enter] key to open the separator entry window.
31. Type appropriate Separator (for example, blank space, STX:, etc.).
32. Press the [Enter] key to close the window.
33. Press the [↓] key to choose "Attach File (MIME)."
34. Press the [Enter] key to open the Attach File (MIME).window.
35. Choose ON(BASE64), ON(UUENCODE) or OFF as appropriate.
 - BASE64: General text converter
 - UUENCODE: UNIX text converter
36. Press the [Enter] key to close the window.
37. Press the [Esc] key four times to return to the standby display.

2.11 E-mail Setup

Choose the LES where to forward e-mail. Also, you may need to register with an LES which provides e-mail services.

1. Press the [F8] key to display the Setup menu.
2. Press the [6] key to choose E-mail Setup.

Setup		E-Mail Setup			
LES Name		AOR.W	AOR.E	POR	IOR
01	Telnor S.S.Inc	001	101	201	321

6. Auto Mode Setup
7. E-Mail Setup
8. Directories
9. Configuration

E-mail setup

3. Press the [Enter] key to open the e-mail station list.

E-Mail Setup					
	LES Name	AOR.W	AOR.E	POR	IOR
01	Telenor S.S.Inc	001	101	201	321
02	Xantic (NED)	012	112	212	312
03	Stratos M.N.	002	102	202	302
04	Telenor S.S.AS	004	104	204	304
05	KDDI	003	103	203	303
06	Singapore T.			210	328
07					
08					

E-mail station list

4. Press the [↓] or [↑] key to choose the LES where e-mail is to be sent.
5. Press the [Enter] key.
6. Press the [Esc] key twice to return to the standby display.

2.12 Saving, Loading System Settings

System settings (as well as messages) may be saved to a floppy disk and loaded onto the terminal unit. This is useful for having backup copies of system settings.

2.12.1 Saving system settings to a floppy disk

1. Insert a formatted floppy disk in the disk drive.
2. Press the [F8] key to show the Setup menu.
3. Press the [8] key to open the Configuration menu.
4. Press the [6] key to choose Save/Load.

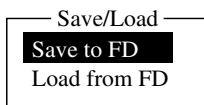

5. Save to FD is selected; press the [Enter] key.

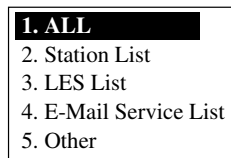

6. Key in the numeric corresponding to the item you want to save. Then, the "OK to save?" appears.
7. Yes is selected; press the [Enter] key to save chosen system setting to the floppy disk.

2.12.2 Loading system settings to the terminal unit

1. Insert floppy disk which contains system settings in the disk drive.
2. Press the [F8] key to show the Setup menu.
3. Press the [8] key to open the Configuration menu.
4. Press the [6] key to choose Save/Load.
5. Press the [↓] key to choose Load from FD and press the [Enter] key.

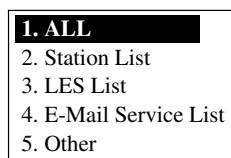

6. Press appropriate numeric key to choose the item to load. The "OK to load" window appears.
7. Yes is selected; press the [Enter] key to load chosen system setting.

3. FILE OPERATIONS

This chapter describes how to prepare, edit, save and print files (messages).

3.1 Files and Working Areas

To create a new message it is necessary to open a new file. After a new file is opened, one of two working areas in the internal memory is secured to create the message. The term “open a file” also refers to the loading of a prepared file into a working area.

When you remove a file from a working area this is called “closing a file.”

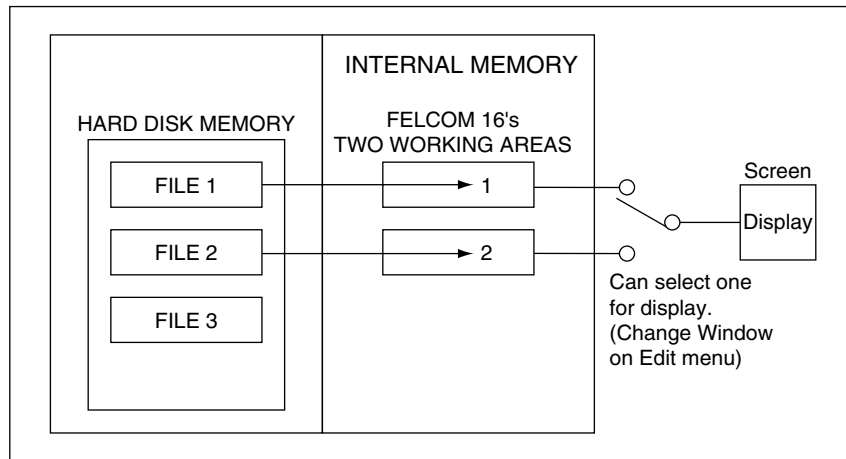

Internal memory

3.2 Preparing Files

There are two types of files: routine and confidential. Files can be assigned a file name and saved to the hard disk for later use. A message may contain maximum 32 Kbytes of characters.

3.2.1 Preparing a routine file

1. Press the [F1] key to display the File menu.

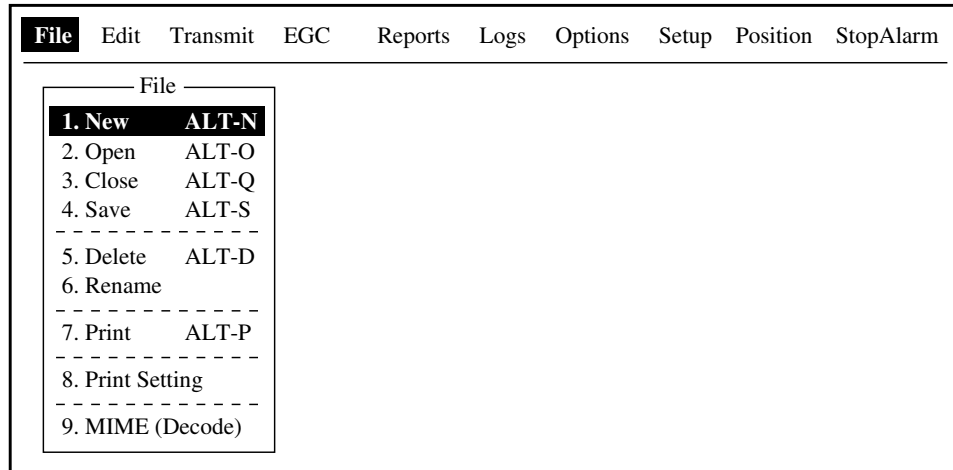

File menu

2. Press the [1] key to choose New. The display should now look something like the illustration below.

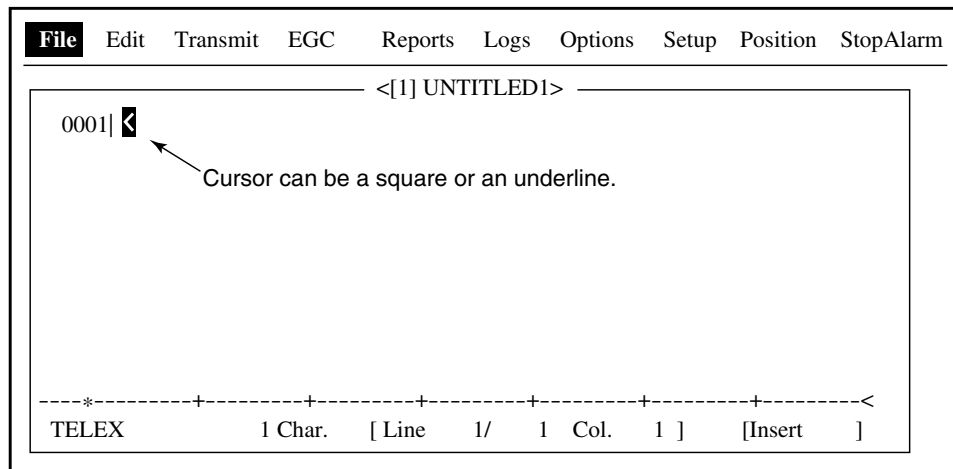

Text editor screen

Note: When two working areas are opened and you try to open a third file, the message "Save this message" appears. When this occurs close an open file to free a working area.

3. The cursor is on the first line. Type your message.
4. To transmit the message you have just prepared, go to paragraph 4.1.2. To save it to the hard disk, for future transmission, go to paragraph 3.3.

3.2.2 Preparing a confidential file

If communicating with another FURUNO FELCOM, you can prepare a confidential message by entering "S???-addressee code(-password):" in the first line of the message text. You can also receive confidential messages containing this header from a land subscriber or any MES.

There are two types of confidential messages: message with addressee code and message with both addressee code and password.

When the FELCOM 16 receives a confidential message, the message is neither displayed nor printed immediately. To display or print the contents of a confidential message, the recipient executes the procedure shown in paragraph 4.2.3.

Addressee code and password

Caller and recipient agree beforehand on both the addressee code and the password. The addressee code might be the title of the recipient; for example, CAPTAIN. The password could be the classification of the message; for example, SECRET.

Preparing message with addressee code

Type the addressee code as shown in the illustration below and then type the text of message.

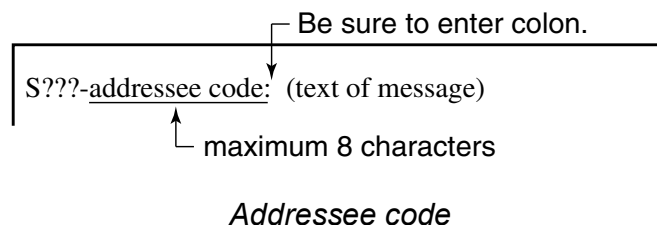

Preparing message with both addressee code and password

Type the addressee code and password as shown in the illustration below and then type the text of message.

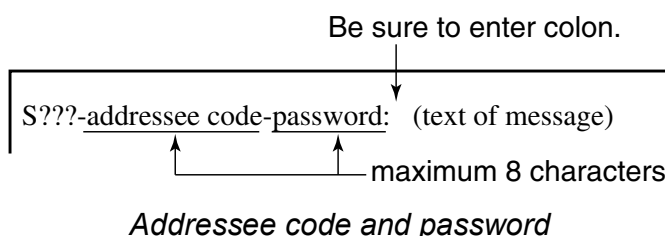

When the recipient receives a message with both addressee code and password, he must enter the password to view contents of the message.

3.2.3 Editor menu setup

The Editor menu sets the parameters of the text editor.

1. Press the [F8] key to display the Setup menu.
2. Press the [2] key to display the Editor Setup menu.

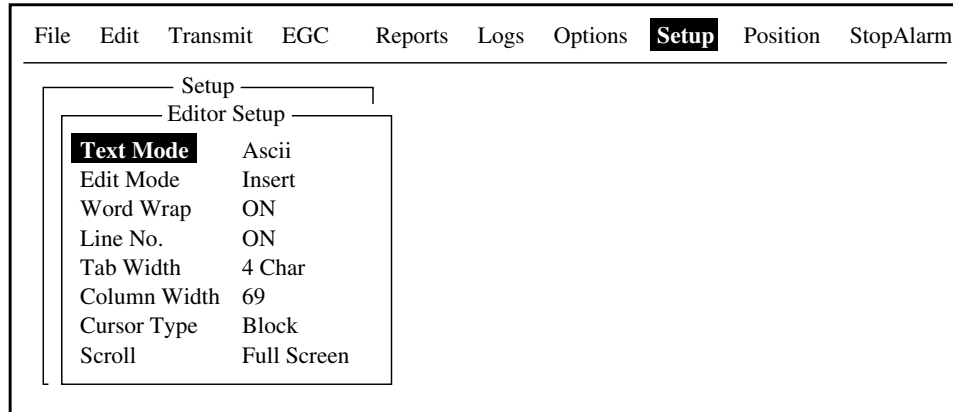

Editor setup menu

3. The illustration above shows the default editor setup settings. To change settings:
 - a) Press the [↓] or [↑] key to choose item.
 - b) Press the [Enter] key to open corresponding options window.
 - c) Press the [↓] or [↑] key to choose setting.
 - d) Press the [Enter] key to register setting.
 - e) Press the [Esc] key twice to return to the standby display.

Text Mode: Choose “Telex” when creating a telex message. Only upper case alphabet is permitted in telex. Use “ASCII” when creating an e-mail message. Upper and lower case alphabet may be used in an e-mail.

Edit Mode: Choose “Insert” (insert character at cursor location) or “Overwrite” (write over character at cursor location).

Word Wrap: Turns on/off automatic hyphenation at the end of a line.

Line No.: Turns line number display on or off.

Tab Width: Sets horizontal tab width; two, four or eight tabs per line.

Column Width: Choose “69” for Telex or “40 to 80” for ASCII.

Cursor Type: Chooses cursor configuration, “█” or underline.

Scroll: Sets how much the screen moves up over the page (Full Screen or Half Screen) when [PgUp] or [PgDn] key is operated.

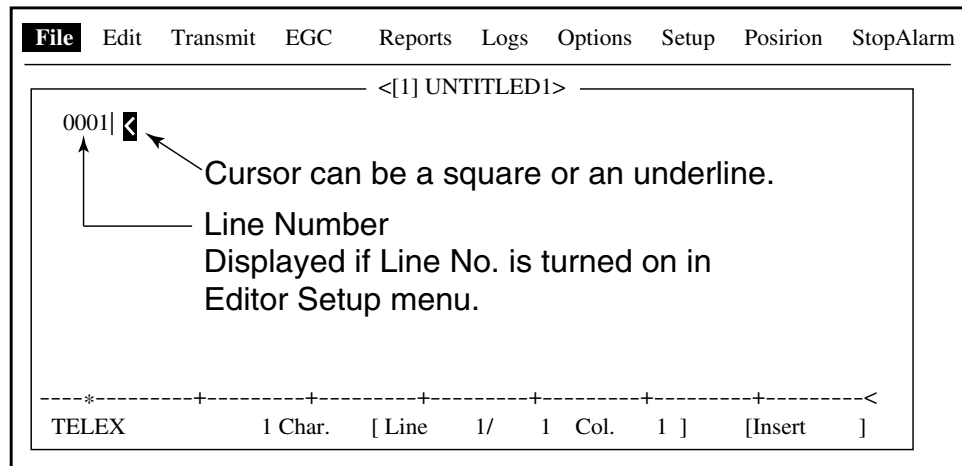

Text editor screen

3.2.4 Working with text

Cutting and pasting text

1. Use the arrow keys to place the cursor on the first character of the text to be cut.
2. Highlight the text to be cut by pressing the [→] key while pressing and holding the [Shift] key. You can use the [←] or [→] key to adjust the highlight. The figure below shows the appearance of highlighted text.

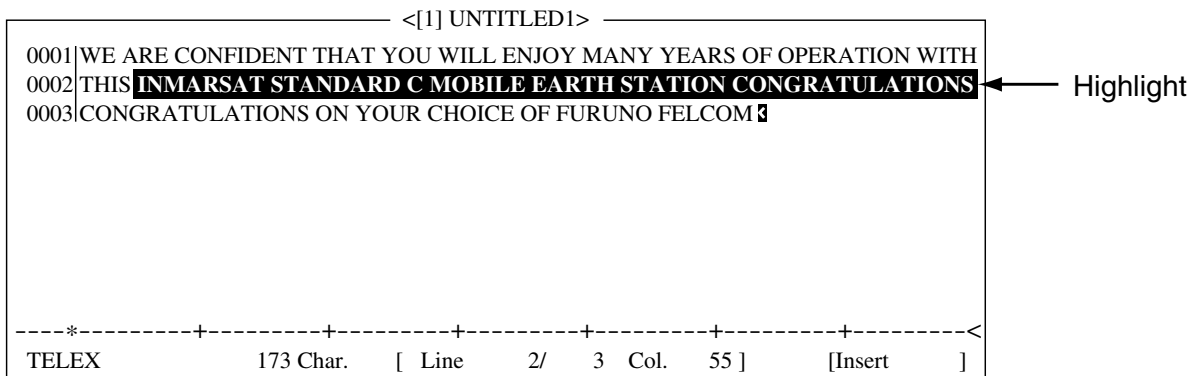

Appearance of highlighted text

3. Press the [F2] key to choose the Edit menu.

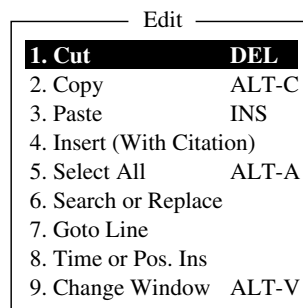

Edit menu

4. Press the [1] key to choose Cut. The highlighted text is cut and the remaining text is reformatted. If a mistake is made, you can immediately restore the text by pressing the [Insert] key.

3. FILE OPERATIONS

- To move text to a new location after it has been cut, place the cursor at the exact spot in the message where the cut text is to start. When the text cursor is placed correctly, press the [F2] key and then the [3] (Paste) key.

Copying and pasting text

- Choose the text you want to copy.

```
<[1] UNTITLED1>
0001|THE FURUNO FELCOM INMARSAT STANDARD C MOBILE EARTH STATION, A
0002|SATELLITE COMMUNICATIONS UNIT PACKAGE FOR VIRTUALLY EVERY VESSEL.
-----*-----+-----+-----+-----+-----+-----+-----+-----<
TELEX          131 Char.  [ Line  2/  2 Col. 66 ]      [Insert  ]
```

Appearance of highlighted text

- Press the [F2] key to display the Edit menu.
- Press the [2] key to choose Copy. The text selected is copied to the clipboard.
- Place the cursor at the exact spot on the message where the copied text is to start.

```
<[1] UNTITLED1>
0001|THE FURUNO FELCOM INMARSAT STANDARD C MOBILE EARTH STATION, A
0002|SATELLITE COMMUNICATIONS UNIT PACKAGE FOR VIRTUALLY EVERY VESSEL.
0003|
      |
      | ← Cursor
-----*-----+-----+-----+-----+-----+-----+-----+-----<
TELEX          131 Char.  [ Line  2/  2 Col. 66 ]      [Insert  ]
```

Cursor selects location where to paste text

- Press the [F2] key followed by the [3] key. The text is placed at the cursor location.

```
<[1] UNTITLED1>
0001|THE FURUNO FELCOM INMARSAT STANDARD C MOBILE EARTH STATION, A
0002|SATELLITE COMMUNICATIONS UNIT PACKAGE FOR VIRTUALLY EVERY VESSEL.
0003|UNIT
-----*-----+-----+-----+-----+-----+-----+-----+-----<
TELEX          137 Char.  [ Line  3/  3 Col.  5 ]      [Insert  ]
```

Text pasted at cursor location

Insert (with Citation)

When you reply to a received message, you can insert the received message. “>” is placed at the head of the received message to distinguish it from your message.

Select All

Chooses the entire current file for cut and copy.

Search and Replace**Searching text**

The Search feature lets you search for text in a forward or backward direction.

1. At the Edit menu, press the [6] key to choose “6 Search or Replace.”

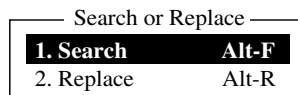
*Search and replace menu*

2. Press the [1] key to choose “1. Search.”

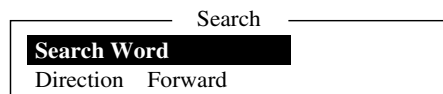
*Search window*

3. Search Word is selected; press the [Enter] key to show the search word entry window.
4. Type the word to find and press the [Enter] key.
5. Press the [↓] key to choose Direction and press the [Enter] key.

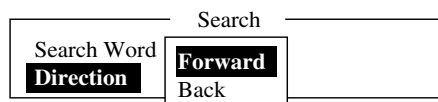
*Direction window*

6. Press the [↓] or [↑] key to choose direction to search from the cursor location; Forward or Back and press the [Enter] key.
7. Press the [Esc] key.

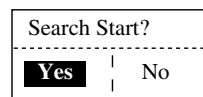
*Search start window*

3. FILE OPERATIONS

8. Yes is selected; press the [Enter] key.

When the unit finds the word, the cursor stops at the first character of the word. If the string could not be found, the message “Not Found (To Quit: ESC)” appears. Press the [Esc] key to quit.

9. To continue the search, press the [Enter] key.

Replacing text

The Replace feature helps you replace every occurrence of a word or phrase with another word or phrase in a file.

1. At the Edit menu, press the [6] key to choose “6 Search or Replace.”

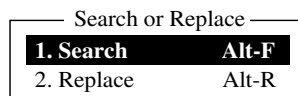

Search and replace menu

2. Press the [2] key to choose “2. Replace.”

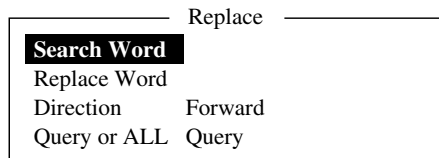

Replace menu

3. Search Word is selected; press the [Enter] key to open the search word entry window.
4. Enter search word and then press the [Enter] key.
5. Press the [↓] key to choose Replace Word and press the [Enter] key.
6. Enter replace word and then press the [Enter] key.
7. Press the [↓] key to choose Direction and then press the [Enter] key.

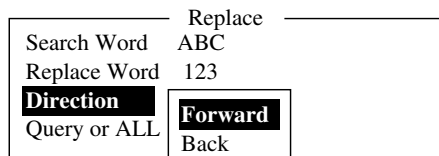

Replace menu, direction menu

8. Press the [↓] or [↑] key to choose direction to search from the cursor location and press the [Enter] key.
9. Press the [↓] key to choose Query or All and then press the [Enter] key.

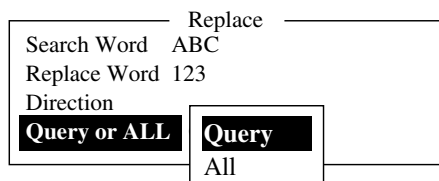

Replace menu, query or all

10. Press the [↓] or [↑] key to choose Query or All.

Query: Stop at each occurrence of word to answer yes or no to replacement.

All: Replace every occurrence of word without stopping to confirm.

11. Press the [Esc] key. The following display appears.

Replace Start?	
Yes	No

Replace start window

12. Yes is selected; press the [Enter] key to start the replacement. If you selected “All” at step 10 all occurrences of the search word are replaced with the replace word. If the string could not be found, the message “Not Found (To quit: ESC)” appears. Press the [Esc] key to quit.

If you selected “Query” at step 10, the message below appears when the search word is found. Press the [Enter] key to replace the word, or hit the Space bar to go to the next occurrence of the search word.

Replace OK? (OK: ENTER Pass: SPACE To quit: ESC)
--

Go to line

Moves the cursor to the desired line in the current file.

Goto Line	
1. Top of Text	HOME
2. End of Text	END
3. Goto Line	

Goto line options

1. Top of text: Go to top of text
2. End of text: Go to end of text
3. Go to line: Specify line number to go to

Time or Pos. Ins

Inserts time or position in a sentence.

1. At the Edit menu, press the [8] key to choose “8. Time or Pos. Ins.”

Time or Pos. Ins.	
1. Time	
2. Position	

Time or position insert options

2. Press the [1] key to insert time; [2] key to insert position at the cursor position.

3.3 Saving Files

After you have created a message you may wish to save it to the hard disk, for future use.

You can save a message two ways: Save it without losing your place on the screen (called “save”), or save it before clearing the screen (called “close”).

3.3.1 Save file, retain place on screen

1. Press the [F1] key to display the File menu.
2. Press the [4] key. The screen should look something like the one below.

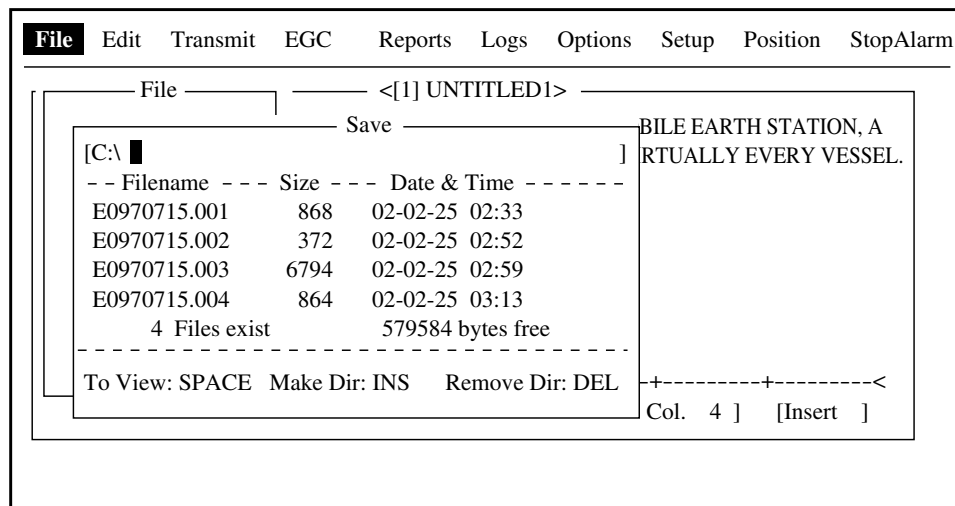

Save screen

3. Enter a file name, up to eight characters with extension name (three characters). You may not use a colon, quotation mark or semicolon or vertical line.

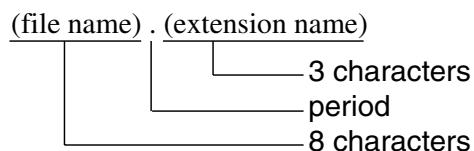

Configuration of file menu

4. Press the [Enter] key to save the file to the hard disk and keep it on the screen.

3.3.2 Save file, clear screen

1. Press the [F1] key to display the File menu.
2. Press the [3] key. The message “Save this message?” appears on the screen.

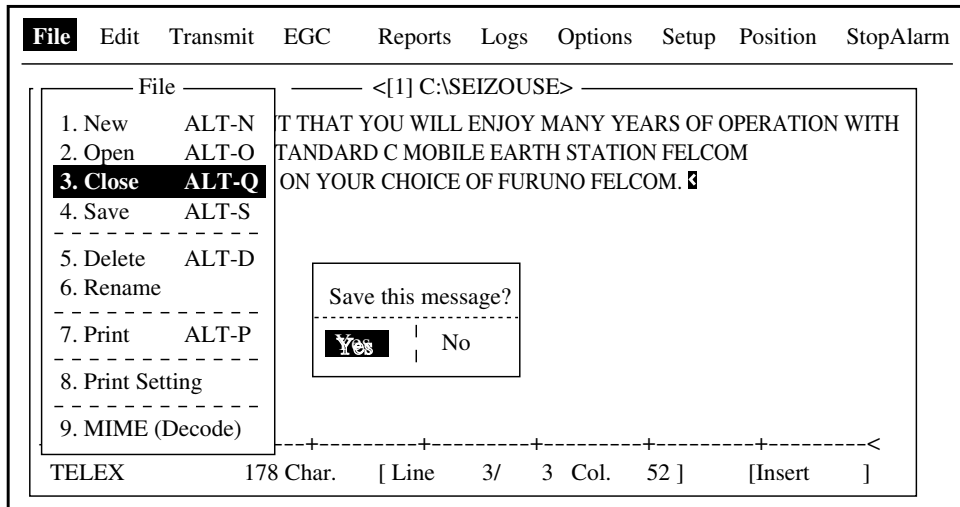

File menu, close file prompt

3. Yes is selected; press the [Enter] key.

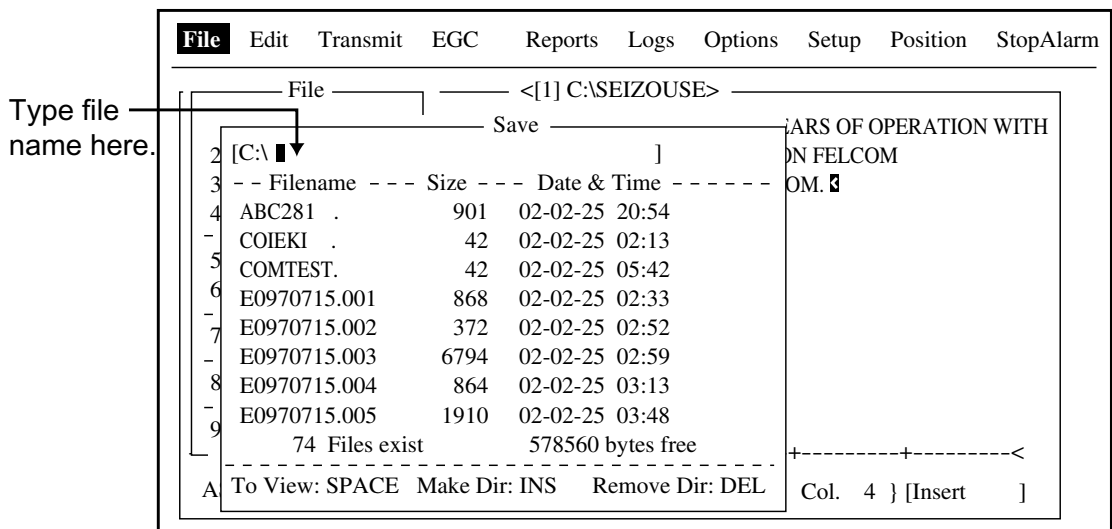

Save screen

4. Enter a file name.
5. Press the [Enter] key to save the file name and clear the screen.

3.4 Opening Files

3.4.1 Opening files

1. Press the [F1] key to display the File menu.
2. Press the [2] key. The screen shows a list of the files stored on the hard disk.
3. Press the [↓] or [↑] key to choose a file.

To view a portion of a file, press the space bar. After confirming, press the [Esc] key.

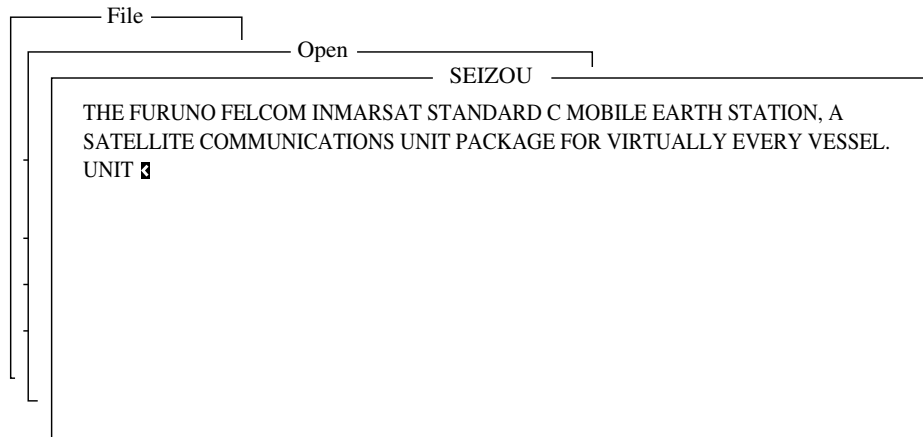

Partial view of a file

4. Press the [Enter] key.

A few moments later the contents of the file appear on the screen and the title bar shows the file name. You may repeat this procedure to load a second file into a working area.

3.4.2 Switching between files

You can switch between files in the working area by pressing the [9] key (Change Window) on the Edit menu ([F2]), or pressing Alt+V on the editor screen.

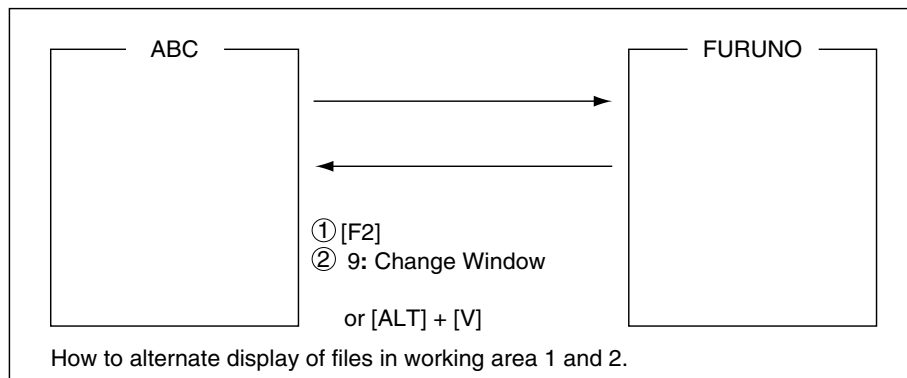

How to switch between files

3.4.3 Opening a file when both working areas are occupied

If both working areas in the memory are occupied when you attempt to open a file, you are asked if you want to save the file currently chosen before clearing it to open another file.

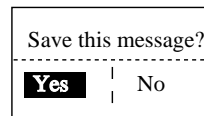

Prompt for closing a file

1. To save the file, press the [Enter] key. (Choose "No" and press the [Enter] key if you do not need to save the file. Go to step 4.)

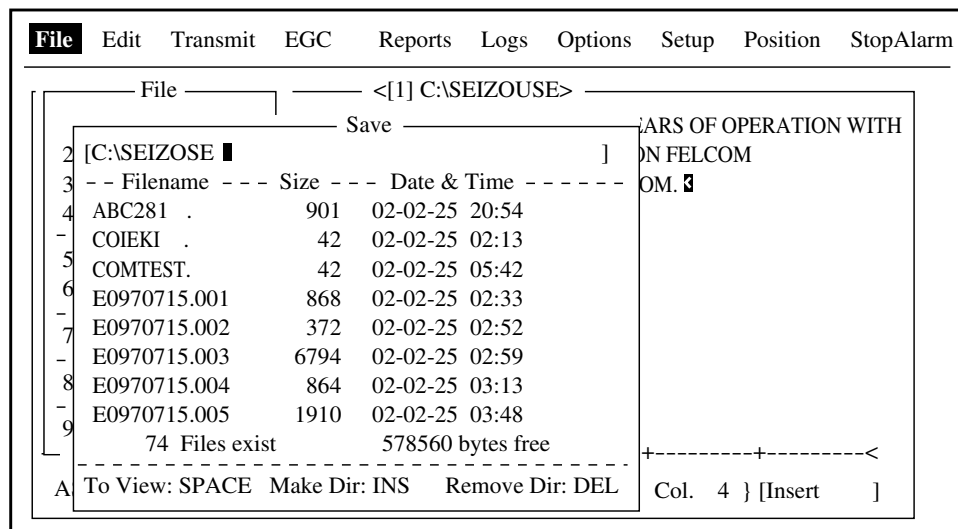

Save screen

2. To enter same file name as edited file, press the [Enter] key.

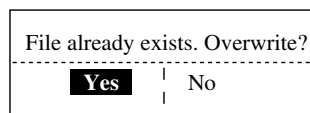

Overwrite file window

3. Yes is selected; press the [Enter] key.
4. Press the [↑] or [↓] key to choose file to open and then press the [Enter] key.

3.5 Saving a File Under a New Name

1. Open a file referring to paragraph 3.4.1.
2. Edit the file.
3. Press the [F1] key.
4. Press the [3] (Close) or [4] (Save) key depending on your objective. [3] saves the file and closes the screen; [4] saves file and keeps position on the screen.

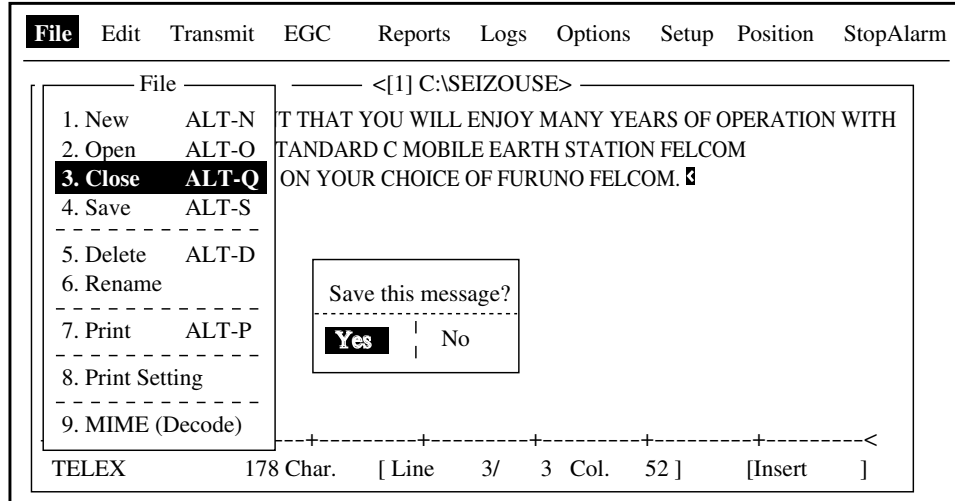

Save screen, prompt for saving a message before closing

5. For “Close,” press the [Enter] key.
6. Press the [Backspace] key to delete original file name. Enter file name for new file.

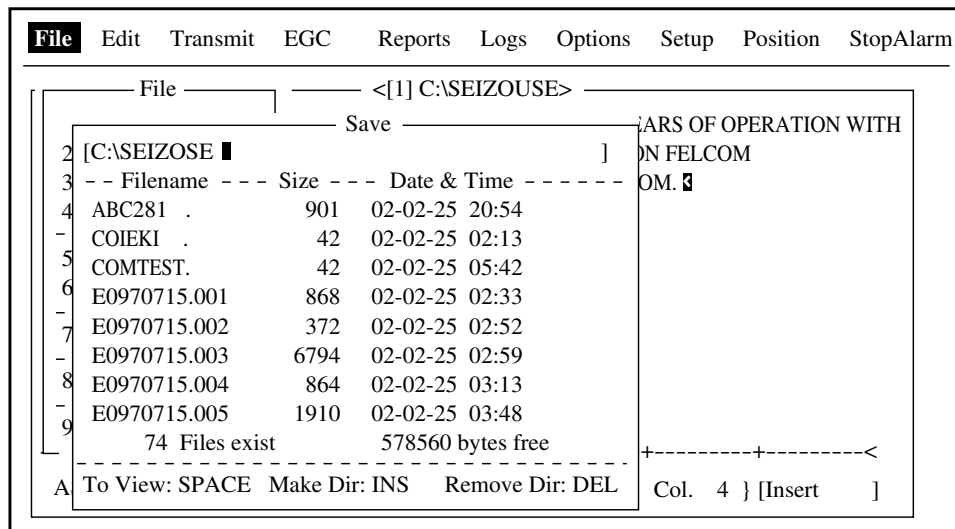

Save screen

7. Press the [Enter] key.

Note: Should you decide to save the file under the original name, skip step 6. The screen shown at the top of the next page appears. Overwrite the file by pressing the [Enter] key, or choose “No” and press the [Enter] key to escape.

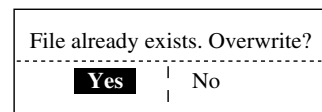

3.6 Printing Files

You can print out a hard copy of a file stored on the hard disk.

1. Press the [F1] key to display the File menu.
2. Press the [7] key. A list of files stored on the hard disk appears.

Print			
Filename	Size	Date & Time	
R0970729.001	412	02-01-10	07:21
SEIZOU .	139	02-01-10	06:22
SEIZOUSE.	117	02-02-25	06:29
T0715 .	836	02-02-23	04:53
T7170 .	20	02-02-18	08:55
TEST .TXT	29	02-01-14	10:03
TESTCAL .	128	02-02-11	15:02
YANOT	146	02-02-10	17:37
75 Files exist		578560 bytes free	
To View: SPACE Make Dir: INS Remove Dir: DEL			

Sample print screen

3. Press the [↑] or [↓] key to choose a file. To get a partial display of the file, tap the space bar. After confirming the file, press the [Esc] key.
4. Press the [Enter] key to print the file.

3.7 Combining Files

In the procedure below we'll combine file A and B.

1. Open file A.
2. Open file B.
3. Place the cursor at the beginning of file B. While pressing and holding down the [Shift] key, press the [↓] key to highlight the entire file. (You can also choose a portion of the file.)
4. Press the [C] key while holding down the [Alt] key to place file B on the clipboard.
5. Press the [V] key while holding down the [Alt] key to switch to File A.
6. Place the cursor at the end of the text and then press the [Enter] key.
7. Press the [Insert] key. File B is inserted at the end of the file A.

3.8 Deleting Files

1. Press the [F1] key to display the File menu.
2. Press the [5] key. A list of files stored on the hard disk appears.

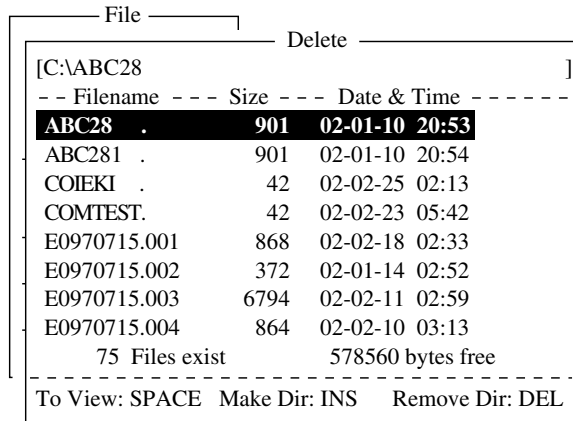

Sample delete screen

3. Press the [↑] or [↓] key to choose the file you want to delete. To verify the contents of that file, tap the space bar. After confirming the contents, press the [Esc] key.
4. Press the [Enter] key. The prompt “OK to delete file?” appears.

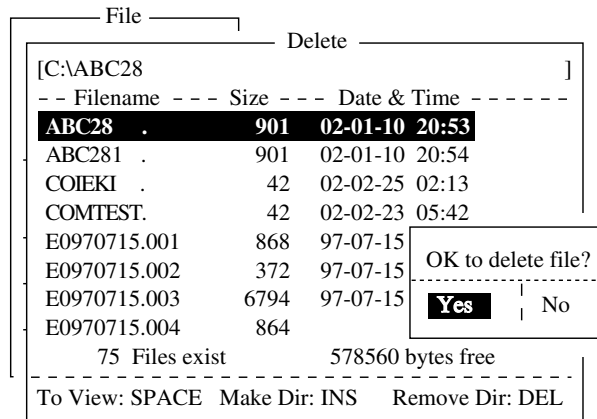

Prompt for verification of file delete

5. Press the [Enter] key to delete the file, or press the [↓] and [Enter] keys to escape.

3.9 Renaming Files

Do the following to rename a file.

1. Press the [F1] key.
2. Press the [G] key.

File		Rename	
[C:\Test]			
-- Filename	---	Size	--- Date & Time
Test		901	02-01-10 20:53
ABC281 .		901	02-01-10 20:54
COIEKI .		42	02-02-25 02:13
COMTEST.		42	02-02-23 05:42
E0970715.001		868	02-02-18 02:33
E0970715.002		372	02-01-14 02:52
E0970715.003		6794	02-02-11 02:59
E0970715.004		864	02-02-10 03:13
75 Files exist		578560 bytes free	
To View: SPACE Make Dir: INS Remove Dir: DEL			

File, rename

3. Press the [↑] or [↓] key to choose the file you want to rename.
4. Press the [Enter] key.

Rename
Enter new filename
Test █

Rename window

5. Delete old file name and then type new file name.
6. Press the [Enter] key.

3.10 Decoding E-mail Attachment

When you can't read an e-mail attachment because it has been coded by MIME (Multipurpose Internet Mail Extensions), you may decode it as below.

1. Save the MIME-coded file to the hard disk. (See paragraph 4.2.5 for the procedure.) This step is not necessary if Auto Receive Message Save is turned on in the Auto Mode Setup menu.
2. Press the [F1] key to open the File menu.
3. Press the [9] key to choose MIME(Decode).

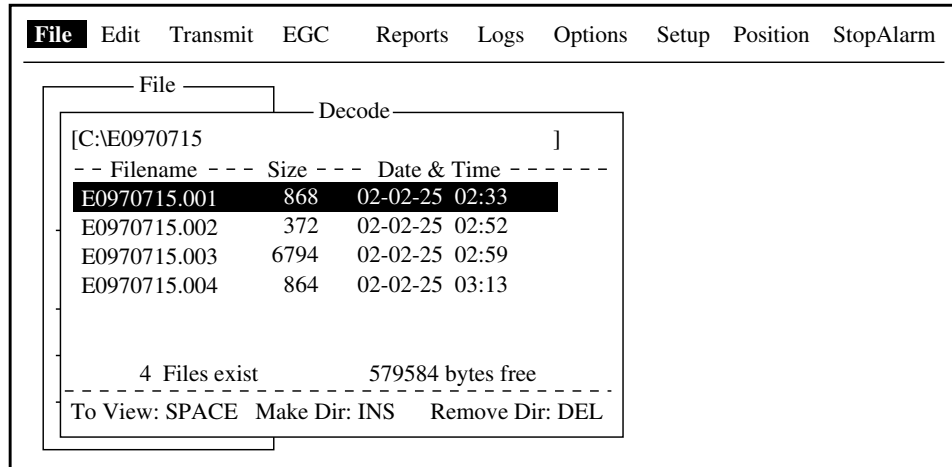

Decode window

4. Press the [↑] or [↓] key to choose the file you want to decode.
5. Press the [Enter] key.

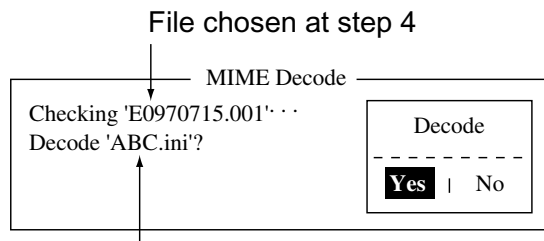

File attachment

Decode window

6. Yes is selected; press the [Enter] key to decode the file.

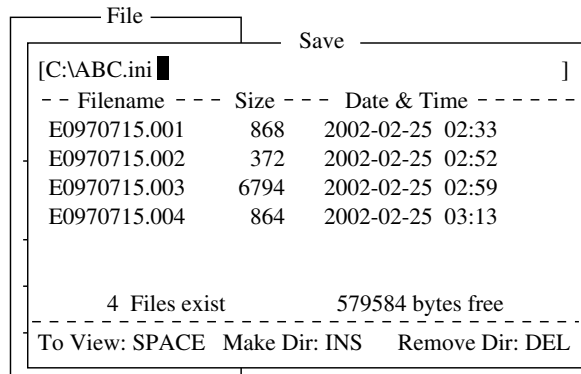

Save window

7. To change file name, press the [Backspace] key to erase the file name, new file name and then press the [Enter] key. After decoding the file the screen looks something like the one shown below.

```
      MIME Decode
-----
Checking 'E0970715.001' ...
Decode 'ABC.ini'?
Now decoding ...
Complete.
Decoded 1 file (s).
Press any key to escape.
```

MIME decode screen

8. Press the [Esc] key twice to return to the standby display.
9. Press the [F1] and [2] keys in that order.
10. Press the [↑] or [↓] key to choose the file selected at step 7 and then press the [Enter] key.

3. FILE OPERATIONS

(This page intentionally left blank.)

4. INMARSAT C COMMUNICATIONS

This chapter explains how to transmit and receive. Before conducting any communications, be sure to login with the NCS in your area, following the instructions in paragraph 2.3.1.

To transmit e-mail, you may need to register for e-mail services with an LES which provides such services. Further it is necessary to register with an LES which provides e-mail services in order to send e-mail from a land subscriber to the FELCOM 16. For further details contact an LES.

4.1 Transmitting

To transmit a message, create the message, attach the address of the recipient and then send it to the LES. The address of the recipient in the Inmarsat C system is his telex number, for transmission via landline, or MES Inmarsat Mobile Number (IMN), when transmitting to a ship.

The message can be one you've just prepared or one stored on the hard disk. (Messages cannot be transmitted by direct keyboard input.)

4.1.1 Code description

Code can be specified at the terminal unit according to data type.

IA5: International alphabet No. 5, ASCII code (7 bit).

Specify this code to transmit English containing lower case alphabet.

ITA2: No. 2 international communications alphabet (5 bit). Specify this code for message which contains only No. 2 international communications alphabet (see A-11). ITA2 code is transmitted faster than IA5 code.

Land-based telex equipment uses ITA2. The LES converts all codes into ITA2. Code which cannot be converted is shown with the question mark (?).

DATA: Data (8 bit). Use this code to transmit data.

4. INMARSAT C COMMUNICATIONS

Message, subscriber, destination type and code

Message	Subscriber	Destination Type	Code	Remarks
English	Inmarsat C MES	Telex	IA5	
	Telex	Telex	ITA2	
	Fax	PSTN	IA5	Modem type "T30 FAX"
	E-mail	E-mail	IA5	
Russian	Inmarsat C MES	PSDN	DATA	
	Fax	Not available		
	E-mail	E-mail	DATA	
Japanese	Inmarsat C MES	PSDN	DATA	
	Telex	Not available		
	Fax	Not available		
	E-mail	E-mail	DATA	Attachment file
Data	Inmarsat C. MES	PSDN	DATA	
	Land Network	PSDN	DATA	

4.1.2 Transmitting prepared message

This section explains how to transmit a message you have just prepared. For code number services, see the table in paragraph 4.1.6.

Transmitting a message to a station registered on station list

1. Prepare message on the screen. For e-mail, set Text Mode in the Editor Setup menu to Ascii. See paragraph 3.2.3. For e-mail attachment, prepare the attachment and save it to the hard disk.
2. Press the [F3] key to display the Transmit menu.

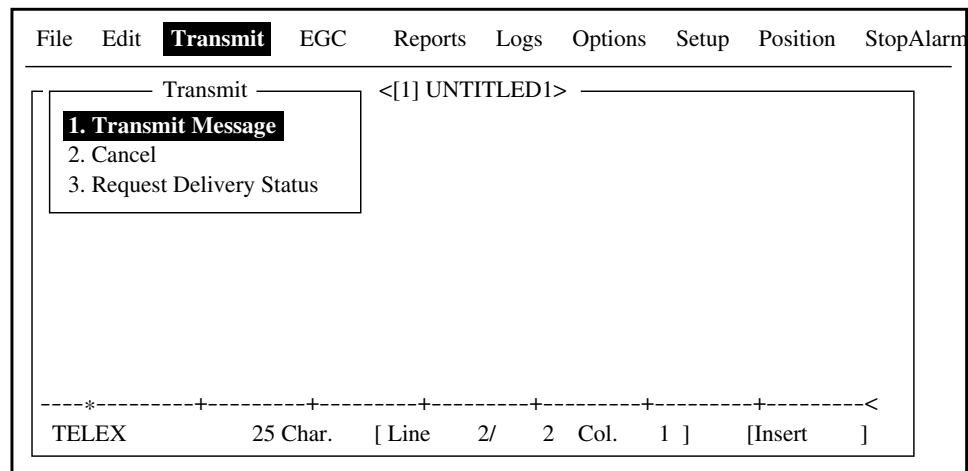

Transmit menu

3. Press the [1] key to display the Transmit Message menu.

Displayed if toll charges have been entered. See para. 2.6.1.

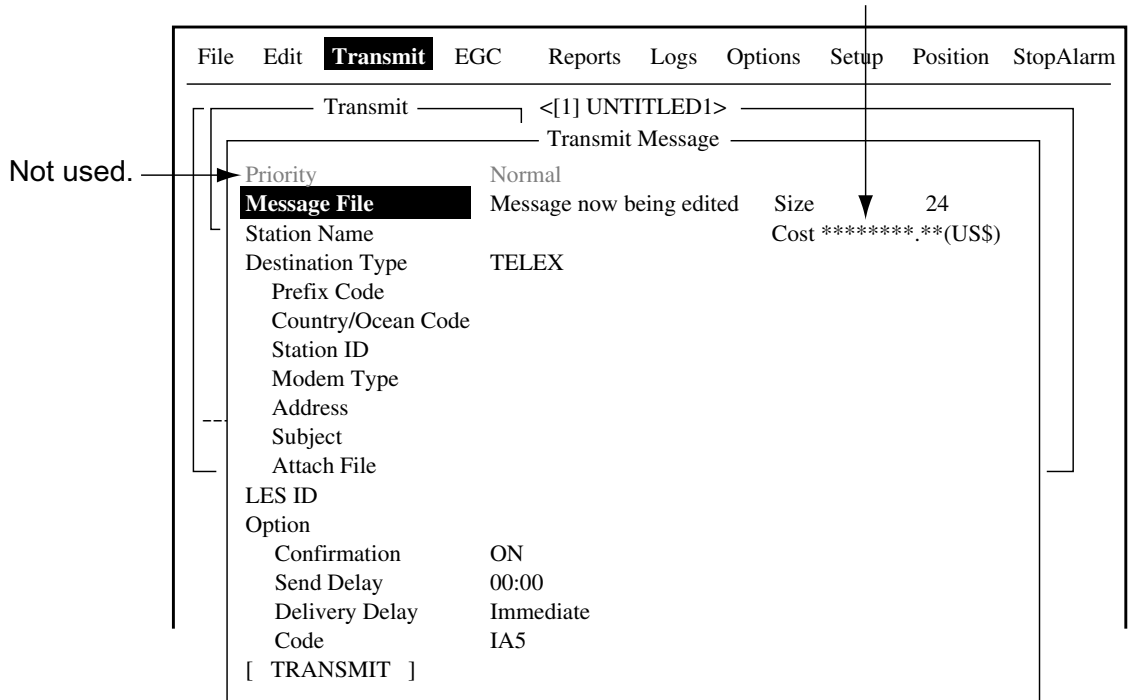

Transmit message menu

4. Press the [↓] key to choose Station Name.

5. Press the [Enter] key to open the Station List.

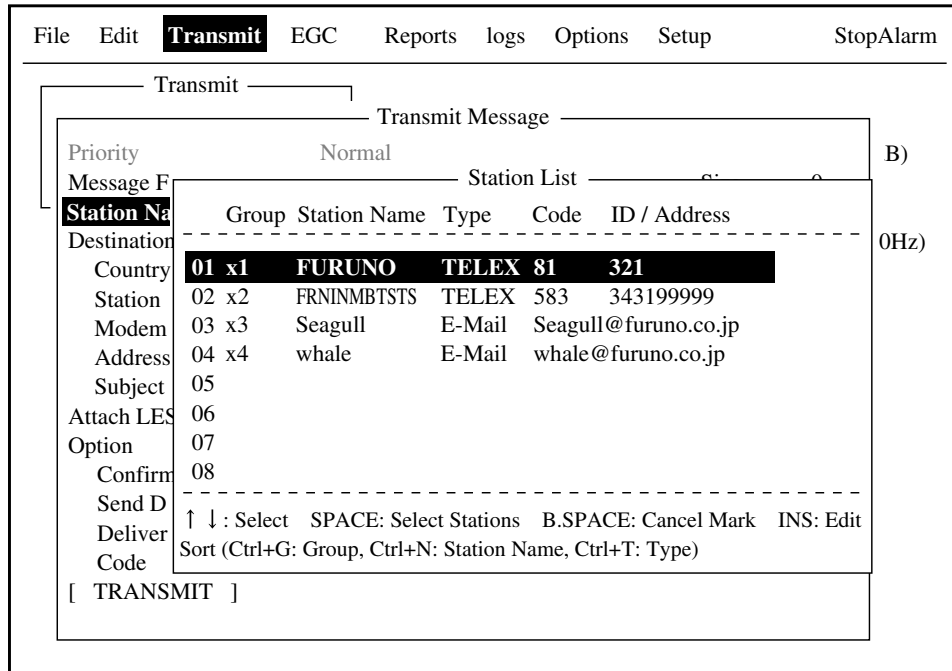

Transmit message menu, station list

4. INMARSAT C OPERATIONS

6. Press the [↑] or [↓] key to choose station and then press the [Enter] key. To choose multiple stations* (simultaneous transmission), choose a station and then press the Space bar. Selected stations are marked with an asterisk (in case of Telex or FAX). For e-mail address, press the Space bar to choose "To" "Cc," Blank, "To"... consecutively. * = Max. 10 telex stations, 7 FAX and 10 e-mail.

Station List					
Group	Station Name	Type	Code	ID / Address	
*01	x1	FURUNO	TELEX 81	321	
*02	x2	FRNINMBTSTS	TELEX	583	343199999
03	x3	Seagull	E-Mail	Seagull@furuno.co.jp	
04	x4	whale	E-Mail	whale@furuno.co.jp	
05					
06					
07					
08					

↑ ↓ : Select SPACE: Select Stations B.SPACE: Cancel Mark INS: Edit
Sort (Ctrl+G: Group, Ctrl+N: Station Name, Ctrl+T: Type)

Station list

- Note 1:** Messages having different communication format or prefix code (two digit code) cannot be sent simultaneously.
- Note 2:** To stop simultaneous transmission (erase asterisk, To or Cc), press the [Backspace] key.
- Note 3:** You may sort the list by group name, station name or communication type as follows:
Group name: Each press of [Ctrl] + [G] sorts the list by group name, ascending or descending order.
Station name: Each press of [Ctrl] + [N] sorts the list by station name, in ascending or descending order.
Comm. type: Each press of [Ctrl] + [T] sorts the list by communication type, in ascending or descending order.
- Note 4:** You may edit the communication charges (see paragraph 2.7.1) from the Station List by pressing the [Insert] key. After editing charges, press the [Esc] key. "OK to save" appears; press the [Enter] key.
7. For E-mail follow the procedure below. For other communication formats go to step 8.
- (1) Press the [↓] key to choose Subject.
 - (2) Press the [Enter] key to open subject entry window.
 - (3) Type subject.
 - (4) Press the [Enter] key to close the window.
 - (5) To attach a file, press the [↓] key to choose Attach File.

(6) Press the [Enter] key to open the attach file window.

Transmit <[1] UNTITLED1>

Transmit Message

Priority Normal

Message File Message now being edited Size 24

Station Name Cost *****.**(US\$)

Destination Type E-Mail

Prefix Code

Country/Ocean Code

Station ID

Modem Type

Address

Subject

Attach File

LES ID

Option

Confirmation

Send Delay

Delivery Delay

Code

[TRANSMIT]

Select File

ENTER: Select DEL: Remove

Transmit message menu, select file window opened

(7) Press the [Enter] key to open the file list window.

(8) Press the [↑] or [↓] key to choose a file and then press the [Enter] key.

(9) Press the [Esc] key to close the window.

8. Press the [↓] key to choose LES ID. If the communication format is e-mail the LES set in paragraph 2.11 appears.

9. Press the [Enter] key to open the LED setting window.

Transmit <[1] UNTITLED1>

Transmit Message

Priority Normal

Message File Message now being edited Size 24

Station Name Cost *****.**(US\$)

Destination Type TELEX

Prefix Code

Country/Ocean Code

Station ID

Modem Type

Address

Subject

Attach File

LES ID

Option

Confirmation

Send Delay

Delivery Delay

Code

[TRANSMIT]

Name	LES ID	Remarks
Telenor S.S.Inc	201	USA
	202	
KDDI	203	JAPAN
Korea Telecom	208	KOREA
Singapore Telecom	210	SINGAPORE (NCS, ID244)

LES ID options

10. Press the [↑] or [↓] key to choose LED desired.

Note: You may edit the communication charges (see paragraph 2.7.1) from the Station List by pressing the [Insert] key. After editing charges, press the [Esc] key. "OK to save" appears; press the [Enter] key.

11. Press the [Enter] key to close the window.

12. Press the [↓] key to choose Confirmation.

4. INMARSAT C OPERATIONS

13. Press the [Enter] key to open the confirmation window.
14. To request notification of delivery from the LES, choose ON. If not necessary choose OFF.
15. Press the [Enter] key to close the window.
16. Press the [↓] key to choose Send Delay.
17. Press the [Enter] key to open the send delay entry window.
18. To send a message after a certain delay, enter a time up to 99 hours 59 minutes. (The Send Delay is used to time message arrival to suit recipient's office hours.)
19. Press the [Enter] key to close the window.
20. Press the [↓] key to choose Delivery Delay.
21. Press the [Enter] key to open the delivery delay options window.
22. Delivery Delay requests the LES for "Immediate" or "Deferred" transmission to the recipient designated. Press the [↑] or [↓] key to choose Immediate or Deferred. For information on this service, consult with LES where message is to be sent.
23. Press the [Enter] key to close the window.
24. Press the [↓] key to choose Code and press the [Enter] key.
25. Press the [↑] or [↓] key to choose "IA5 (for e-mail, fax)", "ITA2 (for telex)" or "DATA" as appropriate.
26. Press the [Enter] key to close the window.
27. Press the [↓] key to place the cursor on TRANSMIT.
28. Press the [Enter] key to open the start window.

Transmit Message

Priority	Normal	Size	46
Message File	SEISETU.TXT	Cost	*****.** (US\$)
Station Name	FURUNO		
Destination Type	TELEX		
Prefix Code			
Country/Ocean Code	81		
Station ID	321		
Modem Type			
Address			
Subject			
Attach File			
LES ID	303 (KDDI)		
Option			
Confirmation	ON		
Send Delay	00:00		
Delivery Delay	Immediate		
Code	IA5		

 |

Transmit message screen

29. Press the [Enter] key to send the message to the message queue. (To escape, choose "No" and press the [Enter] key.) The message "Message is entered in sending Queue. Press any key." appears.

Note 1: If some data has not been entered, the message "Input Error: xx." (xx: error content) appears.

Note 2: When you send a message which contains more than 32 KB of data, the message "Message file is too large (but sent only with 32 KB)." appears. The message is sent with only 32KB of data.

Note 3: Messages sent to the message queue may contain up to 32 KB of data. If data is larger than 32 KB, the message “Cannot enter this message to sending Queue. Press any key.” appears.

30. Press the [Esc] key twice to return to the standby display.

The message(s) will be transmitted according to the Send Delay setting. “Current State: SENDING” appears at the bottom of the screen while the message is being transmitted. If the message was transmitted successfully, “Successful Sending message” appears and the TX message is printed (if “Confirmation is ON”).

Sent Message
DELIVERY CONFIRMATION OFF

Message File	: 00FOX.TXT	Message Size	: 277 characters
LES	: Stratos M.N.	Date	: 02-03-10
Priority	: Normal	Time	: 06:06 (UTC)
Destination	: TELEX (Prefixed)	00111222222222222222 (IA5)	
		00111333333333333333	
		00111444444444444444	

Display log printout example (“Confirmation” OFF)

When Confirmation is ON and you receive a delivery status message, the message “Delivery Status received for (file name).” appears and the delivery status message is printed.

Sent Message
DELIVERY CONFIRMED

Message File	: 00FOX.TXT	Message Size	: 277 characters
LES	: Stratos M.N.	Date	: 02-03-10
Priority	: Normal	Time	: 06:06 (UTC)
Destination	: TELEX (Prefixed)	00111222222222222222 (IA5)	

Display log printout example (“Confirmation” ON, delivery confirmed)

Sent Message but not delivered
DELIVERY FAILURE : xxx

Message File	: 00FOX.TXT	Message Size	: 277 characters
LES	: Stratos M.N.	Date	: 02-03-10
Priority	: Normal	Time	: 06:06 (UTC)
Destination	: TELEX (Prefixed)	00111222222222222222 (IA5)	

Display log printout example (“Confirmation” ON, delivery failed)

Sent Message but not delivered
DELIVERY STATUS NOT RECEIVED (In case of timeout)

Message File	: 00FOX.TXT	Message Size	: 277 characters
LES	: Stratos M.N.	Date	: 02-03-10
Priority	: Normal	Time	: 06:06 (UTC)
Destination	: TELEX (Prefixed)	00111222222222222222 (IA5)	

Display log printout example (“Confirmation” ON, delivery status not received)

TRANSMIT MESSAGE STATUS

The terminal unit displays transmit message status as follows:

Message Send failed. This appears if the message could not be transmitted because of technical reasons such as satellite malfunction, signal degradation, or no reply from LES. Try to transmit the message again.

Message Send rejected. This appears when the LES rejects the message because of non-technical reasons such as unpaid subscriber's fee.

Message Send pending. This appears when the circuits at the LES are busy. Your message will be transmitted when a circuit becomes clear.

Transmitting a message to a station not registered on station list

1. Prepare message. For e-mail, set Text Mode in the Editor Setup menu to Ascii. See paragraph 3.2.3. For e-mail attachment, prepare the attachment and save it to the hard disk.
2. Press the [F3] key to display the Transmit menu.
3. Press the [1] key to show the Transmit Message menu.

Displayed if toll charges have been entered. See para. 2.6.1.

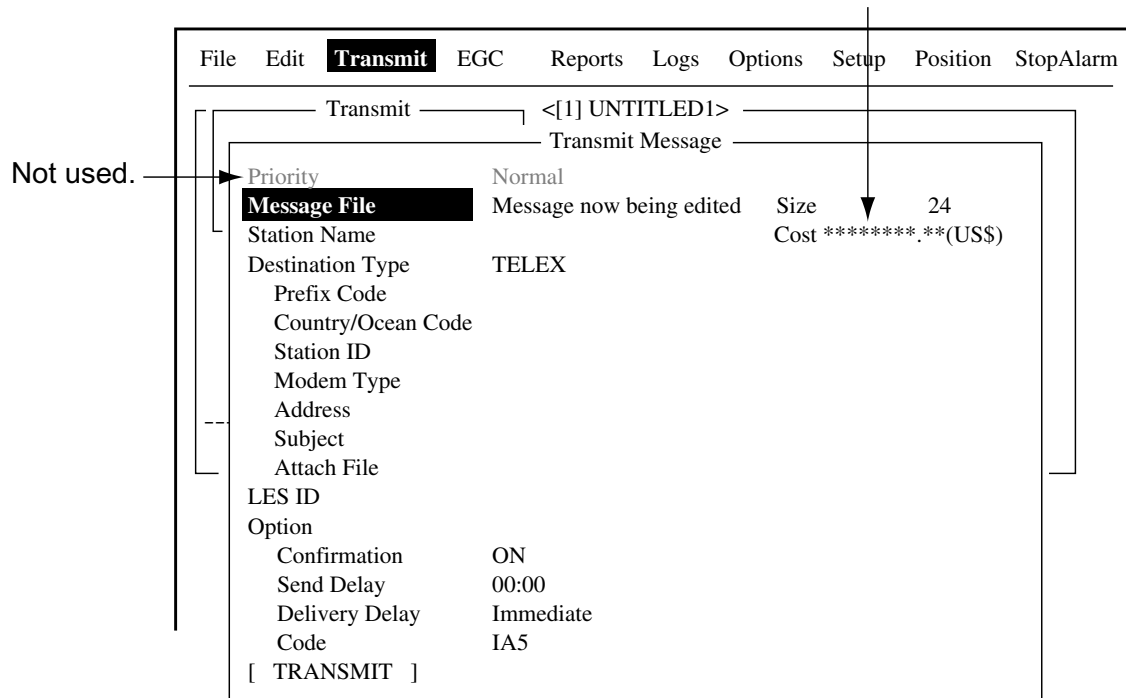

Transmit message menu

4. Press the [↓] key twice to choose the Destination Type.
5. Press the [Enter] key to open the destination type options window.

Transmit		<[1] UNTITLED1>	
Transmit Message			
Priority	Normal	Size	24
Message File	Message now being edited	Cost	*****.**(US\$)
Station Name			
Destination Type	TELEX		
Prefix Code	FAX		
Country/Ocean Code	E-Mail		
Station ID	CSDN		
Modem Type	PSDN		
Address	X400		
Subject	DNID		
Attach File	SPEC		
LES ID	TELEX (Prefixed)		
Option	FAX (Prefixed)		
Confirmation	PSDN (Prefixed)		
Send Delay	X400 (Prefixed)		
Delivery Delay	DNID (Prefixed)		
Code	SPEC (Prefixed)		
	IA5		
[TRANSMIT]			

Transmit message menu, destination type options window

6. Press the [↑] or [↓] key to choose Destination Type among “TELEX,” “FAX” or “E-mail” as appropriate.
7. Press the [Enter] key to close the window.
8. Continue the procedure according to destination type:
 - TELEX: See procedure next page
 - FAX: See procedure on page 4-12
 - E-mail: See procedure on page 4-13

4. INMARSAT C OPERATIONS

Communication type: TELEX

1. Press the [↓] key to choose Country/Ocean Code.
2. Press the [Enter] key to open the country/ocean code entry window.

The screenshot shows a terminal window titled "Transmit Message" within a "Transmit" session. The window displays the following fields and values:

Priority	Normal	Size	24
Message File	Message now being edited	Cost	*****.(US\$)
Station Name			
Destination Type	TELEX		
Prefix Code			
Country/Ocean Code			
Station ID			
Modem Type			
Address			
Subject			
Attach File			
LES ID			
Option			
Confirmation	ON		
Send Delay	00:00		
Delivery Delay	Immediate		
Code	IA5		

[TRANSMIT]

Transmit message menu, country/ocean code window

3. For ship-to-shore telex, enter recipient's telex country code. For example, to use KDDI (Japan) enter 72. For ship-to-ship telex, enter recipient's ocean region.

Ocean Region

AOR-East: 581

POR: 582

IOR: 583

AOR-West: 584

4. Press the [Enter] key to close the window.
5. Press the [↓] key to choose Station ID.
6. Press the [Enter] key to open the station ID entry window.

The screenshot shows the same terminal window as above, but with the "Station ID" field highlighted. The fields and values are identical to the previous screenshot:

Priority	Normal	Size	24
Message File	Message now being edited	Cost	*****.(US\$)
Station Name			
Destination Type	TELEX		
Prefix Code			
Country/Ocean Code			
Station ID			
Modem Type			
Address			
Subject			
Attach File			
LES ID			
Option			
Confirmation	ON		
Send Delay	00:00		
Delivery Delay	Immediate		
Code	IA5		

[TRANSMIT]

Transmit message menu, station ID window opened

7. Type either recipient's telex subscriber number (ship-to-shore) or IMN (ship-to-ship).
8. Press the [Enter] key to close the window.
9. Press the [↓] key to choose LES ID.
10. Press the [Enter] key to open the LES ID entry window.

Transmit <[1] UNTITLED1>

Transmit Message

Priority	Normal		Size	24
Message File	Message now being edited		Cost	*****.(US\$)
Station Name				
Destination Type	TELEX			
Prefix Code				
Country/Ocean Code				
Station ID				
Modem Type				
Address				
Subject				
Attach File				

	LES ID	Remarks
LES ID	Telenor S.S.Inc	201 USA
Option		
Confirmation	202	
Send Delay	KDDI	JAPAN
Delivery Delay	Korea Telecom	KOREA
Code	Singapore Telecom	210 SINGAPORE (NCS, ID244)

[TRANSMIT]

LES ID entry window

11. Press the [↑] or [↓] key to choose LES.
12. Press the [Enter] key to close the LES ID entry window.
13. Follow from step 12 on page 4-5; set Confirmation, Send Delay, Delivery Delay, Code and the choose TRANSMIT to send message.

4. INMARSAT C OPERATIONS

Communication type: FAX

1. Press the [↓] key to choose Country/Ocean Code.
2. Press the [Enter] key to open the country/ocean code entry window.
3. Enter telephone country code of recipient, referring to the list in the Appendix.
4. Press the [Enter] key to close the window.
5. Press the [↓] key to choose to choose Station ID.
6. Press the [Enter] key to open the station ID entry window.
7. Enter recipient's fax number.
8. Press the [Enter] key to close the window.
9. Press the [↓] key to choose Modem Type.
10. Press the [Enter] key to open the modem type options window.

Transmit		<[1] UNTITLED1>	
Transmit Message			
Priority	Normal	Size	24
Message File	Message now being edited	Cost	*****.**(US\$)
Station Name			
Destination Type	FAX		
Prefix Code			
Country/Ocean Code			
Station ID			
Modem Type	T30	FAX	
Address	V21	V.21	300bps Duplex
Subject	V22	V.22	1200bps Duplex
Attach File	V22B	V.22bis	2400bps Duplex
LES ID	V23	V.23	600/1200bps
Option	V26B	V.26bis	2400/1200bps
Confirmation	V26T	V.26ter	2400bps Duplex
Send Delay	V27T	V.27ter	4800/2400bps
Delivery Delay	V32	V.32	9600bps Duplex
Code	Other		
[TRANSMIT]	IA5		

Transmit message menu, modem type options window

11. Press the [↑] or [↓] key to choose modem type. For transmission to landline fax or to fax-equipped Inmarsat B MES, choose "T30." (You cannot transmit a FAX to another Inmarsat C MES.)
12. Press the [Enter] key to close the window.
13. Press the [↓] key to choose LES ID.
14. Press the [Enter] key to open the LES ID window.
15. Press the [↑] or [↓] key to choose LES ID.
16. Press the [Enter] key to close the window.
17. Follow from step 12 on page 4-5; set Confirmation, Send Delay, Delivery Delay, Code and the choose TRANSMIT to send message.

Communication type: E-mail

1. Press the [↓] key to choose Address.
2. Press the [Enter] key to open the address entry window.

Transmit		<[1] UNTITLED1>	
Transmit Message			
Priority	Normal		
Message File	Message now being edited	Size	24
Station Name		Cost	*****.**(US\$)
Destination Type	E-Mail		
Prefix Code			
Country/Ocean Code			
Station ID	INET		
Modem Type			
Address	<input type="text"/>		
Subject	<input type="text"/>		
Attach File	<input type="text"/>		
LES ID	201 (Telenor S.S.Inc)		
Option			
Confirmation	ON		
Send Delay	00:00		
Delivery Delay	Immediate		
Code	IA5		
[TRANSMIT]			

Transmit message menu, address entry window

3. Type recipient's e-mail address.
4. Press the [Enter] key to close the window.
5. Press the [↓] key to choose Subject.
6. Press the [Enter] key to open the subject entry window.

Transmit		<[1] UNTITLED1>	
Transmit Message			
Priority	Normal		
Message File	Message now being edited	Size	24
Station Name		Cost	*****.**(US\$)
Destination Type	E-Mail		
Prefix Code			
Country/Ocean Code			
Station ID	INET		
Modem Type			
Address	<input type="text"/>		
Subject	<input type="text"/>		
Attach File	<input type="text"/>		
LES ID	201 (Telenor S.S.Inc)		
Option			
Confirmation	ON		
Send Delay	00:00		
Delivery Delay	Immediate		
Code	IA5		
[TRANSMIT]			

Transmit message menu, subject entry window opened

7. Type subject.
8. Press the [Enter] key to close the window.
9. If you want to attach a file, press the [↓] key to choose Attach File.

10. Press the [Enter] key to open the select file window.

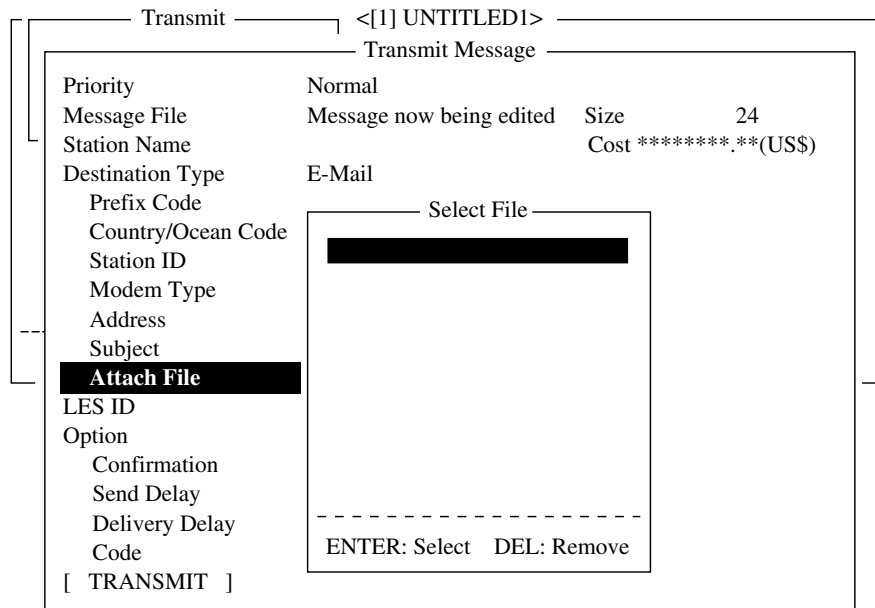

Transmit message menu, select file window

11. Press the [Enter] key to open the file list window.
12. Press the [↑] or [↓] key to choose a file and then press the [Enter] key to close the window.
13. Press the [Esc] key to open the select file window. The LES ID selected at paragraph 2.11 appears.
14. Follow from step 12 on page 4-5; set Confirmation, Send Delay, Delivery Delay, Code and the choose TRANSMIT to send message.

4.1.3 Transmitting a file stored on the hard disk

1. Close any open files.
2. Press the [F3] key to display the Transmit menu.

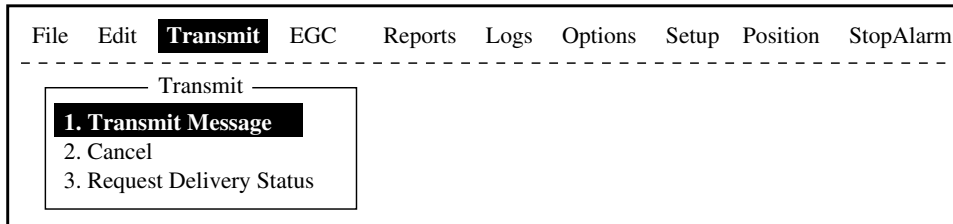

Transmit menu

3. Press the [1] key to choose Transmit Message.

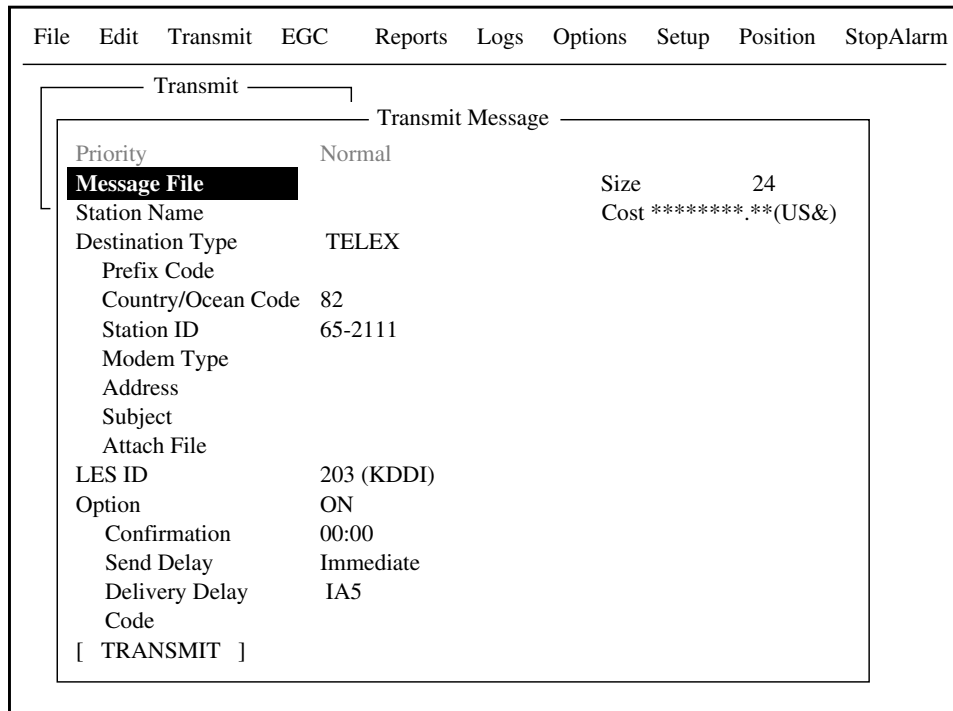

Transmit message menu

4. Press the [↓] key to choose Message File and press the [Enter] key.

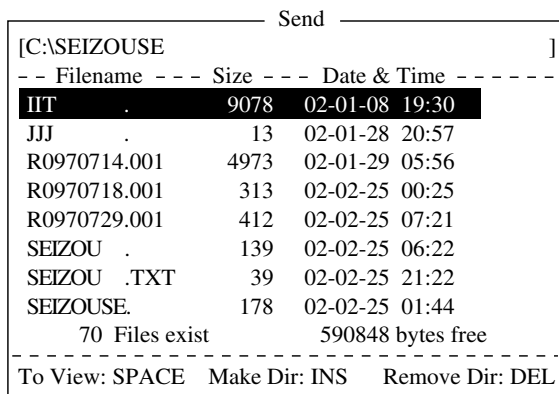

File list

5. Press the [↑] or [↓] key to choose a file and press the [Enter] key. (You can view a part of a file by tapping the space bar. After confirming the contents, press the [Esc] key.)

Note: When an e-mail with attachment is transmitted, the file volume increases by 1.5 times because of MIME coding. In this case, you can do the following to lower toll charges:

- a) Select file to attach from Message File.
 - b) Choose DATA from Code.
6. To transmit the message to a station registered on the station list, follow from step 12 on page 4-5. To transmit to a station not listed on the station list, follow from step 4 on page 4-9.

4.1.4 Canceling transmission on a message awaiting transmission

As noted earlier a transmit message is held in the buffer, usually until it is transmitted satisfactorily. To cancel transmission on a message held in the buffer, do the following:

1. Press the [F3] key to display the Transmit menu.
2. Press the [2] key to display the Cancel screen.

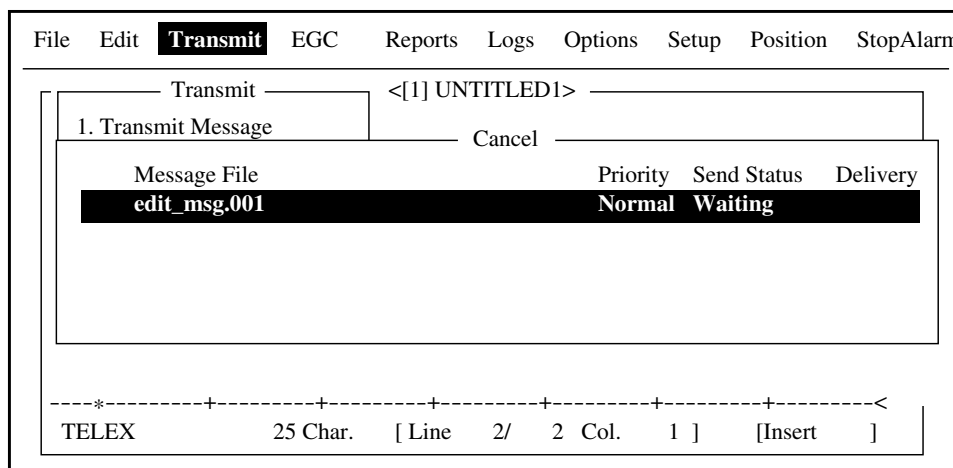

Cancel screen

Send status

Waiting: Waiting to transmit message.

Sending: Now sending message.

Fail: Failed transmission

Rejected: Message rejected by LES.

Pending: LES circuits occupied.

3. Press the [↑] or [↓] key to choose the message you want to cancel.

4. Press the [Enter] key to open the cancel window.

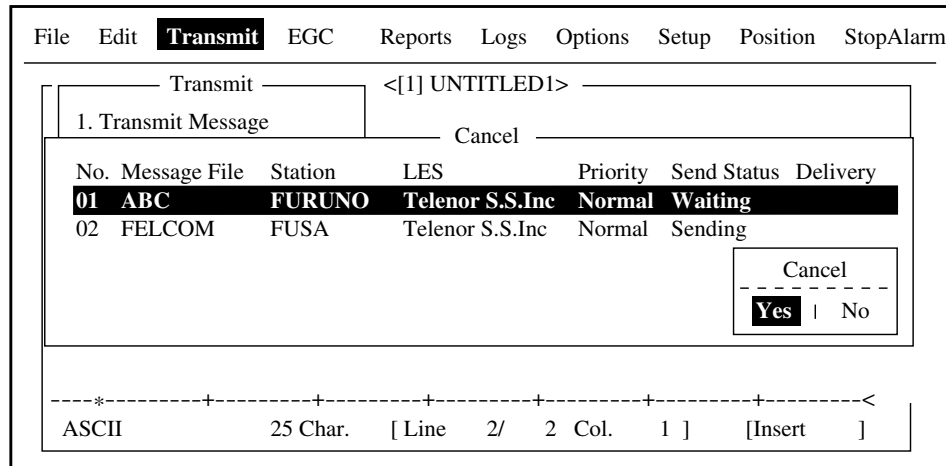

Cancel window

- Press the [Enter] key to cancel a message, or choose “No” and press the [Enter] key to escape from the Cancel menu.
- Press the [Esc] key twice to return to the standby display.

4.1.5 Requesting delivery status

Automatically receiving delivery status

You can automatically receive delivery status of messages you send to a LES, by selecting “Confirming ON” in the Transmit Message menu. Transmitted messages which request delivery status appear in the Message Status List.

The Message Status List holds delivery status information for 30 messages. When the list is full, the oldest entry is deleted to make room for the latest.

1. Press the [F3] key to show the Transmit menu.

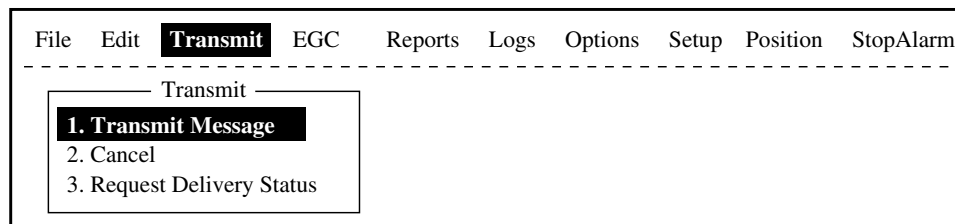

Transmit menu

2. Press the [3] key to display the Request Delivery Status list. If no messages are present “No message.” appears.

Request Delivery Status						
No.	Message File	Station	LES	Priority	Send Status	Delivery
01	ABC	FURUNO	KDDI	Normal	Waiting	
02	DEF	FURUNO	KDDI	Normal	Sending	
03	GHI	ASDFASDF	KDDI	Normal	02-02-26 9:40	OCC(002)
04	JKL		KDDI	Normal	02-02-25 20:16	
05	MNO	ABCDEFGHIJ	KDDI	Normal	02-01-23 16:09	Complete
06	edit msg.002		KDDI	Normal	02-01-22 9:48	EEE(001)
07	edit msg.001		KDDI	Normal	02-01-20 12:34	?????

Sample request delivery states

4. INMARSAT C OPERATIONS

Message status list description

No.:	Message number
Message File:	File name. For no file name, "edit msg. 00X" appears (X = number from 001-999).
Station:	Name of remote party (recipient)
LES:	The LES which received the message.
Priority:	Normal only
Send Status:	The transmission status from the MES (own ship) to the LES; waiting or sending, and data and time of transmission for messages transmitted.
Delivery:	The delivery status from the LES to the recipient. Complete: Message transmitted successfully White space: Delivery status not yet received Reason for no delivery: OCC(002): Delivery tried (twice), but recipient busy. ABS: Absent subscriber BK: Message aborted BMC: No end of message or end of transmission received DER: Out of Order DTE: Remote DTE clearing EOS: Element of Service not subscribed (E-mail) FMT: Format error IAB: Invalid answerback INC: Inconsistent Request (E-mail) INF: Call the Network Information service INV: Invalid Call ITD: Awaiting delivery LDE: Maximum message length exceeded LPE: Local Procedure Error NA: Access Barred NC: Network Congestion NCH: Subscriber's number has been changed NP: Not Obtainable NRC: Reverse charging acceptance not subscribed RIS: Recipient Improperly Specified (E-mail) RDI: Redirected call RPE: Remote Procedure Error RSB: Retransmission still being attempted TMD: Maximum number of addresses exceeded UNK: Unknown status (for example when the Logical channel number is zero)

Note: Some codes may not be used depending on LES.

Manually requesting delivery status

You can manually request an LES for delivery status of a message you have transmitted within the past 24 hours.

1. Press the [F3] key to display the Transmit menu.
2. Press the [3] key to display the Request Delivery Status list.

Request Delivery Status						
No.	Message File	Station	LES	Priority	Send Status	Delivery
01	ABC	FURUNO	KDDI	Normal	02-02-25 16:10	
02	edit msg.002	FURUNO	KDDI	Normal		

Request delivery status display

3. Press the [↑] or [↓] key to choose a file.
4. Press the [Enter] key. The start window appears.

Request Delivery Status						
No.	Message File	Station	LES	Priority	Send Status	Delivery
01	ABC	FURUNO	KDDI	Normal	02-02-25 16:10	
02	edit msg.002	FURUNO	KDDI	Normal		

Start

Yes No

Sample message file list

5. Yes is selected; press the [Enter] key to request status. If request was successful the message "Successful Deliver Status Request." appears.
6. Press the [Esc] key twice to return to the standby display.

Several minutes later the message "Delivery status received for (file name)" appears on the display. The reply from the LES appears in the Delivery column of the Request Delivery Status list.

4.1.6 Accessing the code number services

A range of special safety and general maritime services, known as the code number services, may be transmitted. The list on the next page shows the code number services available.

To access a code number service do the following:

1. Using the text editor, prepare message requesting a code number service.
2. Press the [F3] key to open the Transmit menu.
3. Press the [1] key to display the Transmit Message menu.

Displayed if toll charges have been entered. See para. 2.6.1.

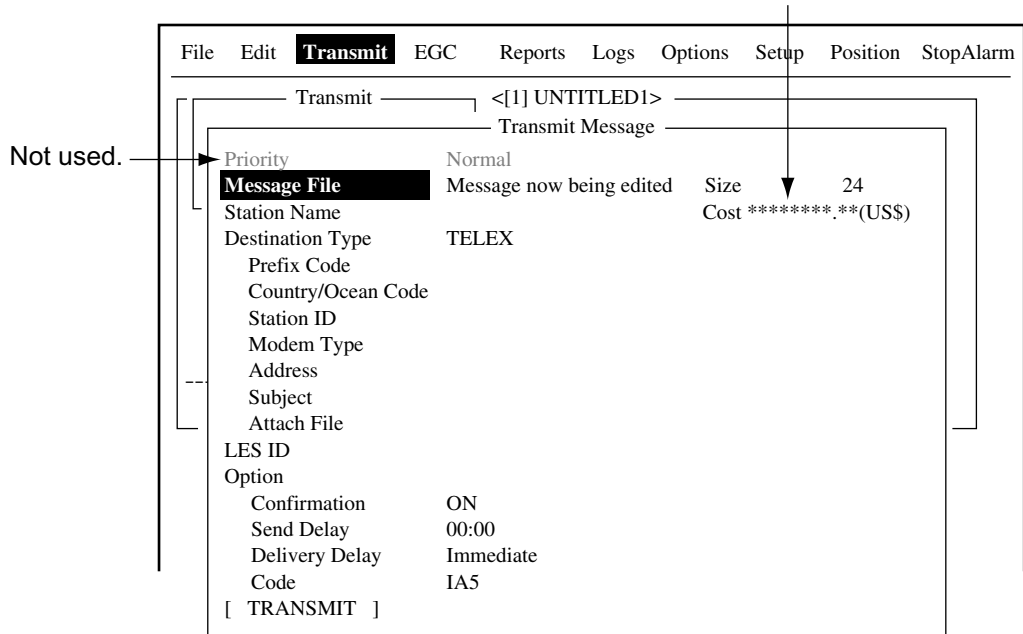

Transmit message menu

4. Press the [↓] key twice to choose Destination Type.
5. Press the [Enter] key to open the destination type options window.
6. Press the [↓] or [↑] key to choose SPEC (Special).
7. Press the [Enter] key to close the window.
8. Press the [↓] key to choose Station ID.
9. Press the [Enter] key to open the station ID entry window.
10. Key in code number referring to the table on the next page.
11. Press the [Enter] key to close the window.

Maritime safety service code number services

Code	Content	Remarks
31	Maritime enquiries	Desirable for requesting information including service offerings.
32	Medical advice	Used for requesting medical advice.
33	Technical assistance	Desirable for addressing technical enquiries to appropriate personnel.
37	Time and charges requested at end of call	Desirable for mobile operator when sending traffic for a third party.
38	Medical assistance	Used for requesting medical assistance.
39	Maritime assistance	Used for requesting maritime search and rescue assistance
41	Meteorological reports	Necessary for ease of addressing weather reports from ship to meteorological centers.
42	Navigational hazards and warnings	Used for making urgent navigational meteorological danger reports.
43	Ship position reports	Used for routing of messages to ship safety reporting systems.

12. Press the [↓] key to choose LES ID.

13. Press the [Enter] key to open the LES window.

14. Press the [↑] or [↓] key to choose appropriate LES and press the [Enter] key.

15. Press the [↓] key to choose TRANSMIT.

16. Press the [Enter] key to show the start window.

17. Press the [Enter] key to transmit the message prepared.

Note: If some data is missing the message “Input error.xx (xx: error) is displayed.

18. Press the [Esc] key twice to return to the standby display.

The message “Current State: SENDING” appears at the bottom of the screen during transmission. If the message was transmitted successfully “Successful Sending message” appears and the message is printed (Confirmation is turned ON). You can see the contents on the Display Log.

Note 1: At present, not all LESs are offering the code number services. Contact the LES Operations Coordinator directly for information.

Note 2: Some code number services may be provided free of charge by LESs, while other services are available for a fee, in some cases at reduced rates. For information, contact the LES directly.

4.1.7 Displaying the send message log

1. Press the [F6] key to display the Logs menu.

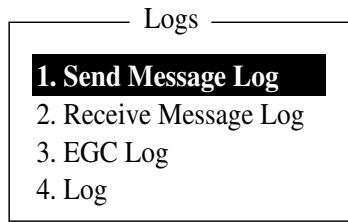

Logs menu

2. Press the [1] key to show the Send Message Log. The contents are the same as the Request Deliver Status list. (See page 4.17.)

Send Message Log

No.	Message File	Station	LES	Priority	Send Status	Delivery
01	ABC	FURUNO	KDDI	Normal	Waiting	
02	DEF	FURUNO	KDDI	Normal	Sending	
03	GHI	ASDFASDF	KDDI	Normal	02-02-26 9:40	OCC(002)
04	JKL		KDDI	Normal	02-02-25 20:16	
05	MNO	ABCDEFGHIJ	KDDI	Normal	02-01-23 16:09	Complete

ENTER: Show Details

Send message log

3. Press the [↑] or [↓] key to choose a file.
4. Press the [Enter] key to show data.

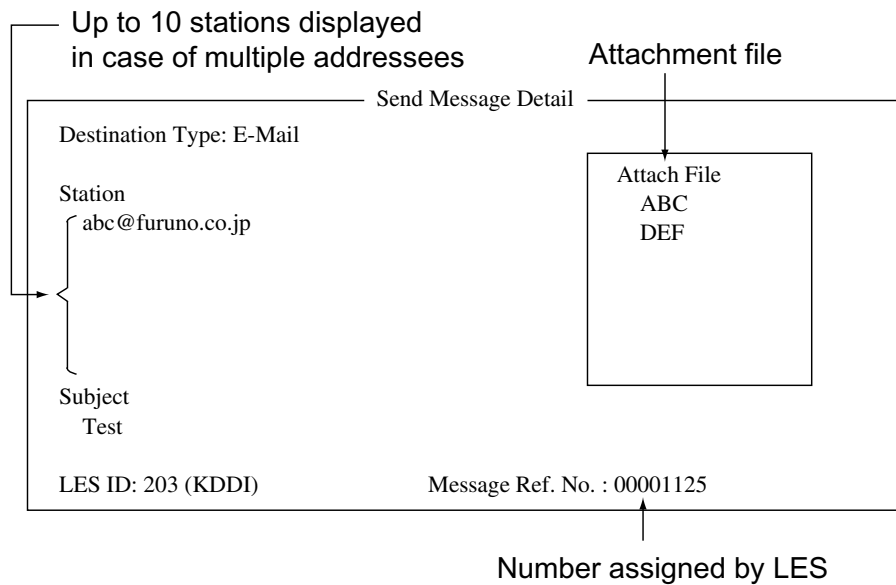

Send message details (example: e-mail)

5. Press the [Esc] key three times to return to the standby display.

4.2 Receiving

4.2.1 When a message is received

Each time the FELCOM 16 receives a telex or e-mail it displays the message "Successful Receiving message." If Auto Receive Message Save and Auto Receive Message Print in the Auto Mode Setup are set for ON, the message is automatically saved and printed (except confidential and password affixed messages).

Received message alarm

If Receive Alarm in the Auto Mode Setup menu is set for ON, the audio sounds when a telex or e-mail is received. You may silence the alarm with the [F10] key.

Registration

Each message received is assigned a message number. This number is also used when saving the file to the hard disk.

<u>R</u>	<u>0</u>	<u>0 3</u>	<u>0 4</u>	<u>2 5</u>	<u>0 0 1</u>
Receive	0: PC	year	month	day	receive message no.

Message number

Log

The Log (see paragraph 4.3) shows message number, priority, date and time of transmission, LES ID and file size (in bytes) of the latest 50 received and transmitted messages.

Printing

When Auto Receive Message Print in the Auto Mode Setup menu is set for ON, received messages (except confidential and password affixed messages) are automatically printed. Manual printing is also available.

Saving and filing

The terminal unit saves and files a received message to the Display Message List. The Display Message List shows the following:

- Received message no.
- LES ID
- Priority
- File size (in bytes)
- Message classification
- Password for confidential messages
- Date and time of transmission
- Status

4.2.2 Setting the receive alarm

An audio alarm may be set to sound when a routine or confidential message is received. The factory setting is OFF. Set alarm volume at the PC.

1. Press the [F8] key to display the Setup menu.
2. Press the [5] key to display the Auto Mode Setup menu.

Auto Mode Setup	
Auto Log Print	OFF
Receive Alarm	OFF
Auto Receive Message Save	OFF
Auto Receive Message Print	OFF
Data Report & Polling Print	OFF
Auto EGC Message Save	
Auto EGC Message Print	

Auto mode setup menu

3. Press the [↓] key to choose Receive Alarm.
4. Press the [Enter] key to open the Receive Alarm options window.
5. To enable the audio alarm, choose ON. As soon as ON is selected a beep sounds. The alarm will be released when a telex or e-mail is received.
6. Press the [Enter] key to close the window.
7. Press the [Esc] key twice.

4.2.3 Displaying, printing received messages

Received messages (except confidential or password affixed) are automatically printed when the Auto Receive Message Print in the Auto Mode Setup is turned on. To print confidential or password affixed messages follow the procedure below.

If you cannot read an e-mail attachment (because it is MIME-coded), go to paragraph 3.10.

1. Press the [F6] key to show the Logs menu.

Logs	
1. Send Message Log	
2. Receive Message Log	
3. EGC Log	
4. Log	

Logs menu

2. Press the [2] key to display the list of received messages.

Received Message Log						
Message No.	LES	Priority	Size	Addressee	Rec date & Time	Status
R0971106.001	KDDI	Normal	32767		02-02-06 16:10	Saved
R0971105.002	KDDI	Normal	200	CAPTAIN	02-02-05 17:30	
R0971105.001	KDDI	Normal	1234		02-02-05 14:15	Printed
R0971024.001	KDDI	Normal	8251		02-01-24 13:20	Saved
Memory Available: 12345 Bytes						
ENTER: Display S: Save D: Delete						

Receive message log

Display message list description

- Message No.:** Received message no.
- LES:** LES name
- Priority:** Normal
- Size:** Size of file in bytes
- Addressee:** Addressee code appears for confidential messages. Nothing appears for routine messages.
- Rec date & time:** Date and time message was received.
- Status:**
 - Printed: message printed
 - Saved: message saved to hard disk
 - No display: not yet printed confidential message, or printer malfunction
- Memory available:** Received message memory available in the terminal unit

3. Choose a file. To get a partial display of a file selected, tap the space bar. A part of the file appears in the View Window. Press the [Esc] key to return.
4. Press the [Enter] key for routine messages and messages with addressee code (no password).

Display Receive Message <R0971123.002->	
FROM FURUNO	
TO FRONTIER	
THE QUICK BROWN FOX JUMPS OVER LAZY DOG.	
ABCDEFGHIJKLMN OPQRSTUVWXYZ. 1234567890	
Ctrl+P: Print	

Sample received message

4. INMARSAT C OPERATIONS

For messages with both addressee code and password, the password entry window appears. Enter the password and then press the [Enter] key. If the password is entered incorrectly, the buzzer sounds. Reenter the password.

Receive Message Log						
Message No.	LES	Priority	Size	Addressee	Rec date & Time	Status
R0021106.001	KDDI	Normal	767		02-11-06 16:10	Saved
R0021105.002	KDDI	Normal	200	(CAPTAIN)	02-11-05 17:30	Printed
R0021105.001	KDDI	Normal	1234		02-11-05 14:15	Printed
R0021101.001	KDDI	Normal	3256	OFFICER	02-11-01 3:45	Printed
R0021024.001	KDDI	Normal	8251		02-10-24 13:20	Saved

Memory Available

PASS WORD: █

Enter: Display S: Save D: Delete

Location of password

- To print a message, press the [P] key while pressing the [Ctrl] key.

Receive Message (SECRET)

↑ Appears only for confidential messages

Message No. : R0970323.001

Message Ref. No. : 00000000

LES : LES or LES ID

Priority : Normal

Message Size : 205 characters

Receive Date & Time : 02-02-25

abcdefghijklmnopqrstuvwxyz..... ← Text

Sample printout

- Press the [Esc] key three times to return to the standby display.

About attachments

The FELCOM 16 receives a file with an attachment over a landline two ways.
(The method depends on the LES.)

- Mail main text and text mail which includes information about the attachment.
- Attachment data

Mail and attachment file data

Attachment data

Receive Message Log

Message No.	LES	Priority	Size	Addressee	Rec date & Time	Status
R0021105.002	KDDI	Normal	18		02-11-05 17:40	Printed
R0021105.001	KDDI	Normal	210		02-11-05 17:30	Printed
R0021104.001	KDDI	Normal	1234		02-11-04 14:15	Printed
R0021101.001	KDDI	Normal	3256	OFFICER	02-11-01 3:45	Printed
R0021024.001	KDDI	Normal	8251		02-10-24 13:20	Saved

Memory Available: 3317 Bytes

Enter: Display S: Save D: Delete

Receive message log

Some files stored on the Receive Message Log may not be readable. Choose the file and press the [Enter] key. If the file is unreadable, because it is in a language other than English (for example, Japanese). Press the [S] key to save the file to the hard disk. Open the file with a different application.

One attachment

Display Receive Message <R0021105.001->

FROM : FURUNO
TO: FRONTIER
1 attachment
18 bytes, test
Text
Ctrl+P: Print

Attachment name

Example of main text and text mail with attachment data

4.2.4 Automatically printing received messages

You may automatically print received messages (except confidential or password affixed) as follows:

1. Press the [F8] key to display the Setup menu.
2. Press the [5] key to display the Auto Mode Setup menu.

Auto Mode Setup	
Auto Log Print	OFF
Receive Alarm	OFF
Auto Receive Message Save	OFF
Auto Receive Message Print	OFF
Data Report & Polling Print	OFF
Auto EGC Message Save	
Auto EGC Message Print	

Auto mode setup menu

3. Press the [↑] or [↓] key to choose Auto Receive Message Print.
4. Press the [Enter] key.
5. Press the [↑] key to choose ON.
6. Press the [Enter] key to close the window.
7. Press the [Esc] key twice.

4.2.5 Saving received messages to the hard disk

1. Press the [F6] key.
2. Press the [2] key to display the Receive Message Log.

Receive Message Log						
Message No.	LES	Priority	Size	Addressee	Rec date & Time	Status
R0971106.001	KDDI	Normal	32767		02-02-04 16:10	Saved
R0971105.002	KDDI	Normal	200	CAPTAIN	02-02-05 17:30	Printed
R0971105.001	KDDI	Normal	1234		02-02-05 14:15	Printed
R0971101.001	KDDI	Normal	3256	OFFICER	02-02-01 3:45	Printed
R0971024.001	KDDI	Normal	8251		02-01-24 13:20	Saved
Memory Available: 3317 Bytes						

ENTER: Display S: Save D: Delete						

Sample delete message screen

3. Press the [↑] or [↓] key to choose a file. To confirm contents of a file, press the [Enter] key. For confidential messages, the password entry window appears after pressing the [Enter] key. Enter the password and press the [Enter] key.
4. Press the [S] key to copy the file to the hard disk. For confidential messages the password entry window appears. Enter password and press the [Enter] key.

Note: If a file by that name already exists on the hard disk, "Already exist on DISK." appears.

4.2.6 Automatically saving received messages to the hard disk

You may automatically save received messages other than confidential or password-affixed messages to the hard disk as follows:

1. Press the [F8] key.
2. Press the [5] key to display the Auto Mode Setup menu.

Auto Mode Setup	
Auto Log Print	OFF
Receive Alarm	OFF
Auto Receive Message Save	OFF
Auto Receive Message Print	OFF
Data Report & Polling Print	OFF
Auto EGC Message Save	
Auto EGC Message Print	

Auto mode setup menu

3. Press the [↑] or [↓] key to choose Auto Receive Message Save.
4. Press the [Enter] key to open the auto receive message save options window.
5. Press the [↑] key to choose ON.
6. Press the [Enter] key to close the window.
7. Press the [Esc] key twice.

Note: To designate directory where to store receive messages, see paragraph 2.9.2.

4.2.7 Deleting received messages

1. Press the [F6] key to display the Logs menu.
2. Press the [2] key to choose Receive Message Log.

Receive Message Log						
Message No.	LES	Priority	Size	Addressee	Rec date & Time	Status
R0971106.001	KDDI	Normal	32767		02-02-04 16:10	Saved
R0971105.002	KDDI	Normal	200	CAPTAIN	02-02-05 17:30	Printed
R0971105.001	KDDI	Normal	1234		02-02-05 14:15	Printed
R0971101.001	KDDI	Normal	3256	OFFICER	02-02-01 3:45	Printed
R0971024.001	KDDI	Normal	8251		02-01-24 13:20	Saved
Memory Available: 3317 Bytes						
ENTER: Display S: Save D: Delete						

Sample receive message log

3. Press the [↑] or [↓] key to choose the message you want to delete. You can confirm the contents of the message by pressing the [Enter] key. For password-affixed messages, the password entry window appears. Enter the password and press the [Enter] key. After confirming the contents, press the [Esc] key.
4. Press the [D] key. You are asked if you are sure to delete the message. For password affixed-message, the password entry window appears. Enter password and press the [Enter] key.

Receive Message Log						
Message No.	LES	Priority	Size	Addressee	Rec date & Time	Status
R0021106.001	KDDI	Normal	32767		02-11-06 16:10	Saved
R0021105.002	KDDI	Normal	200	CAPTAIN	02-11-05 17:30	Printed
R0021105.001	KDDI	Normal	1234		02-11-05 14:15	Printed
R0021101.001	KDDI	Normal	3256	OFFICER	02-11-01 3:45	Printed
R0021024.001	KDDI	Normal	8251		02-10-24 13:20	Saved
Memory Available: 3317 Bytes						
Delete ----- Yes No						
Enter: Display S: Save D: Delete						

Delete window

5. Press the [Enter] key to delete the message, or choose No and then press the [Enter] key to escape.
6. Press the [Esc] key twice to return to the standby display.

4.3 Display Log

The Display Log stores the particulars of the latest 50 received and transmitted messages. When the log becomes full, the oldest message is automatically deleted.

4.3.1 Displaying and printing the display log

1. Press the [F6] key to display the Logs menu.
2. Press the [4] key to show the Display Log.

	2	3	4	5	6	Log	7	8	9	10	11
1	S/R	Message No.	Type	Pri	Date	Time	LES	Station	Size	Cond	
	01 S	T0971110.001	TELEX	Nrm	02-02-25	19:10	302	FURUNO	12345	Success	
	02 R	R0971110.001	TELEX	Nrm	02-02-25	19:25	302	- - - - -	365	Success	
	:										
	:	50 (max)									
	Ctrl+P: Print										

Sample display log

3. To scroll the Display Log screen, press the [↓] key several times.
4. To print the log, press the [P] key while pressing the [Ctrl] key and press the [P] key. To stop printing, press the [Esc] key.

Display log description

- 1) Log no.
- 2) S/R S: Send message, R: Received message
- 3) Message No.: Message no. or file name
- 4) Type: Message type (Telex, e-mail, etc.)
- 5) Pri: Communications priority; "Nrm" is for general administrative communications.
- 6) Date: Date message was received (transmitted).
- 7) Time: Time message was received (transmitted).
- 8) LES: ID of LES which handled the message
- 9) Station: Transmitting station name. Blank for unregistered station or received message.
- 10) Size: Size of message in bytes
- 11) Cond: Transmission results. Blank if a received message.
 Success: Successful transmission
 Fail: Failed transmission
 Rejected: Message rejected by LES

4.3.2 Automatic printing of display log

The Display Log can be automatically printed every 24 hours as follows:

1. Press the [F8] key to display the Setup menu.
2. Press the [5] key to display the Auto Mode Setup menu.

Auto Mode Setup	
Auto Log Print	OFF
Receive Alarm	OFF
Auto Receive Message Save	OFF
Auto Receive Message Print	OFF
Data Report & Polling Print	OFF
Auto EGC Message Save	
Auto EGC Message Print	

Auto mode setup menu

3. Auto Log Print is selected; press the [Enter] key.
4. Press the [↑] key to choose ON.
5. Press the [Enter] key to close the window.
6. Press the [Esc] key twice to return to the standby display. The log will be printed at 00:00 (UTC) each day.

4.4 EGC Messages

When an EGC message is received, RECEIVING EGC MESSAGE appears at the bottom left corner of the display. If Auto Message Save in the Auto Mode Setup is ON, EGC messages are automatically saved. EGC messages are automatically received, printed and saved to the terminal unit selected with EGC Output Port on the System Setup menu. The memory capacity for EGC message is 32 Kbytes. When the EGC message memory becomes full, the oldest EGC message is automatically deleted.

4.4.1 Displaying and reprinting EGC messages

1. Press the [F4] key.

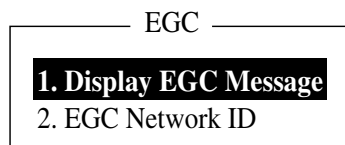

EGC menu

2. Press the [1] key to show the Display EGC Message screen.

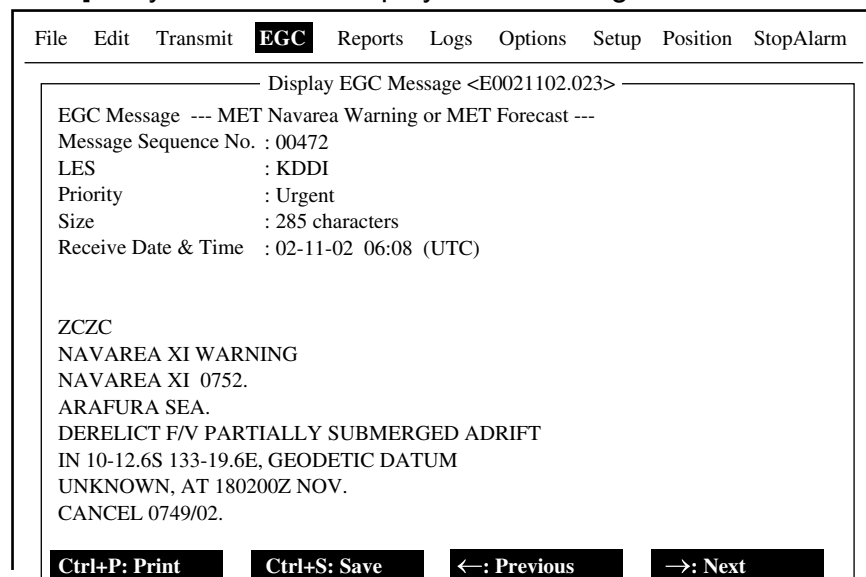

Sample display EGC message screen

3. Press the [↑] or [↓] key to scroll the screen.
4. To print a message, press the [P] key while pressing the [Ctrl] key and press the [P] key. To stop printing, press the [Esc] key.
5. To save the message, press the [S] key while pressing the [Ctrl] key.
6. Press the [Esc] key to return to the standby display.

EGC messages can be automatically saved to the hard disk. See paragraph 2.4.4 for details.

4.4.2 Displaying EGC closed network ID (ENID)

To join a FleetNET™ service, an MES must be registered with an information provider. The information provider adds the MES to the group which is to receive the service, by downloading a Group Call ID (via an LES which supports FleetNET™ broadcasts), uniquely addressed to the MES. The MES stores the ID and can accept broadcasts from the information provider. The MES operator cannot change this stored EGC closed network IDs (ENIDs). Up to 64 ENIDs are stored on a non-volatile memory.

The ENID stored can be accessed for downloading and deleting via the satellite path. It is possible for an MES operator to inhibit (or activate as required), via the terminal unit, selected ENIDs previously downloaded.

Along with the ENID the name of the information provider is stored. In the event that a download command is received and the ENID storage area is full, an ENID which has been inhibited (de-activated) by the MES operator will be written over. If none has been inhibited, then the new download is not accepted.

Follow the procedure below to inhibit or activate an ENID.

1. Press the [F4] key to display EGC menu.
2. Press the [2] key to display the EGC Network ID List.

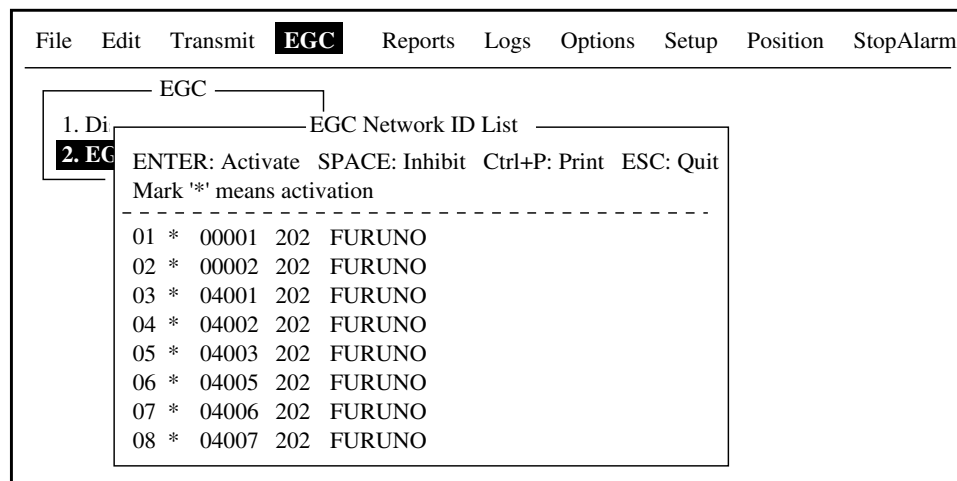

EGC network ID list

3. Press the [↑] or [↓] key to choose the ENID you want inhibit (or activate).
4. Press the space bar to inhibit, or the [Enter] key to activate. The asterisk mark disappears when an ENID is inhibited.
5. Press the [Esc] key to return to the standby display.

4.4.3 Displaying the EGC message log

1. Press the [F6] key to show the Logs menu.
2. Press the [3] key to display the EGC message log.

EGC Message Log						
Message No.	LES	Priority	Size	Seq. No.	Rec date&Time	Type
E0021118.028	KDDI	Urgent	428	01641	02-11-18 10:27	ME
E0021117.002	KDDI	Safety	1455	02035	02-11-17 05:23	U.M Rct
Memory available: 32767 Bytes						

ENTER: Display S: Save D: Delete						

EGC message log

- Scroll: Press the [↑] or [↓] key.
- Display message: Press the [Enter] key.
- Save message: Press the [S] key.
- Delete message: Press the [D] key. The Delete window appears and Yes is selected; press the [Enter] key.
3. Press the [Esc] key twice to return to the standby display.

4. INMARSAT C OPERATIONS

(This page intentionally left blank.)

5. DATA REPORTING AND POLLING

This chapter provides the information necessary for data reporting and polling reception. Data reporting provides automatic data transmission at regular intervals from your ship to your home office. When your ship receives a polling command from your home office; that is, a request for navigation data from your ship, it automatically transmits this data to your home office.

No operator intervention is required during polling reception.

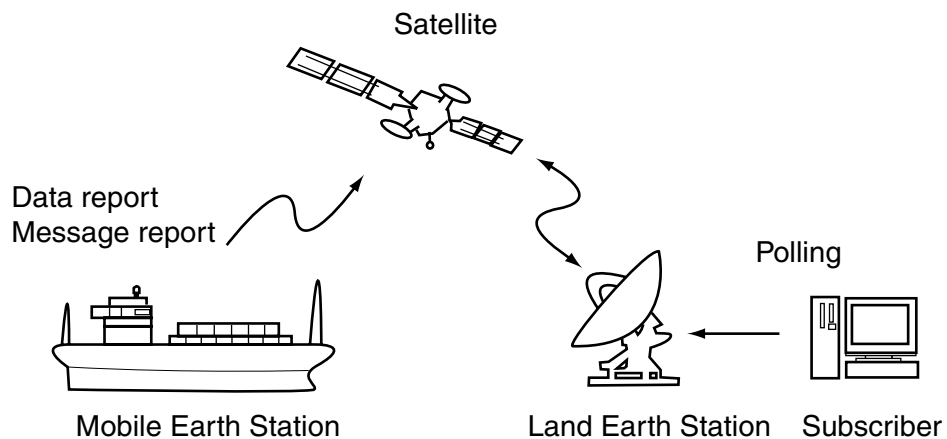

5.1 Data Reporting

Data reporting provides automatic data transmission at predetermined intervals from your ship to your home office. The data are position, speed, bearing and other data sent from the internal GPS navigator.

The data transmitted from the FELCOM 16 is temporarily stored in a data reporting file at the LES. When an operator at your home office accesses the LES, the LES delivers the data to your home office. Some LESs may deliver it without being accessed.

Data reporting can be initiated by setting a data report on the FELCOM 16 or receiving a polling command from your home office.

FELCOM 16 offers two types of reports as follows:

- Data reporting (on MES signaling channel)
Refer to paragraph 5.1.1.
- Message reporting (on MES message channel)
Refer to paragraph 5.1.2.

5.1.1 Setting a data report

1. Press the [F5] key to display the Reports menu.



Reports menu

2. Press the [1] key to choose Data Report.

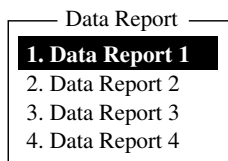

Data report menu

3. Press [1], [2], [3] or [4] as appropriate.

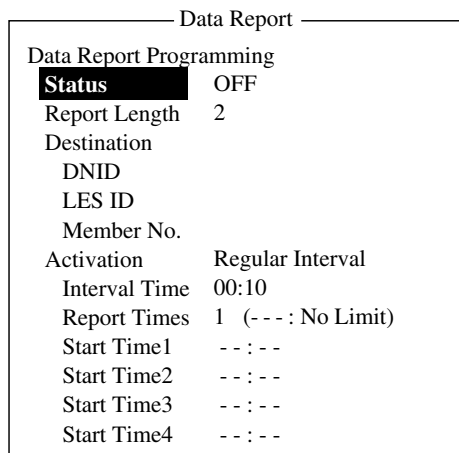

Data report menu

4. Status is selected; press the [Enter] key to open the status options window.
5. Press the [↓] or [↑] key to choose “ON” or “OFF” as appropriate.
ON: Data report on
OFF: Data report off
6. Press the [Enter] key to close the window.
7. Press the [↓] key to choose Report Length.
8. Press the [Enter] key to open the report length options window.
9. Press the [↓] or [↑] key to choose “1” or “2” as appropriate.
1: Position
2: Position, speed, course, depth
3: Spare (not used)
10. Press the [Enter] key to close the window.
11. Press the [↓] key to choose Destination.
12. Press the [Enter] key to show the DNID list.
13. Choose DNID (Data Network ID) desired and press the [Enter] key. (LES ID and Member No. are automatically selected according to DNID.).
14. Press the [↓] key to choose Activation.
15. Press the [Enter] key to open the activation options window.

- 16. Press the [↓] or [↑] key to choose “Regular Interval” or “Daily” as appropriate.
- 17. Press the [Enter] key to close the window.
- 18. Do one of the following depending on the selection you made at step 16.

“Regular Interval” selected at step 16

- (1) Press the [↓] key to choose Interval Time.
- (2) Press the [Enter] key to open the interval time entry window.
- (3) Key in the interval time. The interval should be at least 10 minutes.
- (4) Press the [Enter] key to close the window.
- (5) Press the [↓] key to choose Report Times.
- (6) Press the [Enter] key to open the report times entry window.
- (7) Key in the report times, or press the [Back Space] key to display “---” to choose “No Limit” to transmit data until the “Status” setting is turned OFF.
- (8) Press the [Enter] key to close the window.

“Daily” selected at step 16

- (1) Press the [↓] key to choose Start Time 1.
- (2) Press the [Enter] key to open the start time entry window.
- (3) Key in the start time, in 24-hour notation.
- (4) Press the [Enter] key to close the window.
- (5) If necessary enter start times for Start Time 2-4.

- 19. Press the [Esc] key to show the update window.

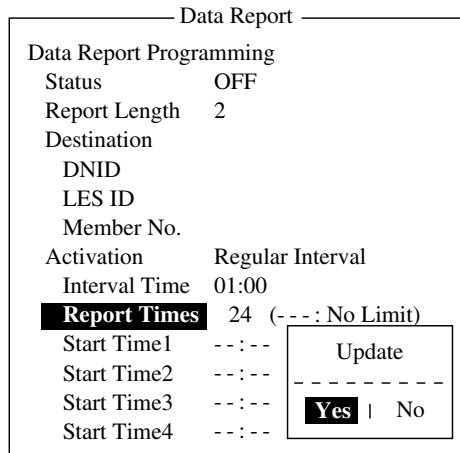

Data report menu (regular interval reporting)

- 20. Yes is selected; press the [Enter] key to register settings.
- 21. Press the [Esc] key to return to the standby display.

5.1.2 Setting a message report

1. Press the [F5] key to display the Reports menu.



Reports menu

2. Press the [2] key to display the Message Report menu. Four addresses may be registered.

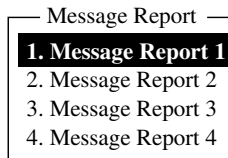

Message report menu

3. Press [1], [2], [3] or [4] as appropriate

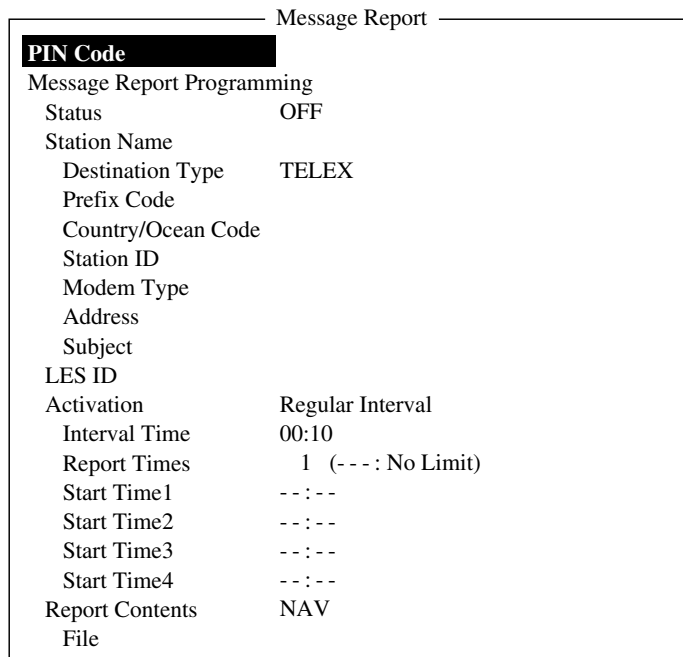

Message report menu

4. Press the [↓] key to choose Status.
5. Press the [Enter] key to open the status options window.
6. Press the [↓] or [↑] key to choose “ON” or “OFF” as appropriate.
 - ON: Message report on
 - OFF: Message report off
7. Press the [Enter] key to close the window.
8. Press the [↓] key to choose Station Name.
9. Press the [Enter] key to display the Station List.

10. Press the [↓] or [↑] key to choose a station.

Note: You may sort the list by group name, station name or communication type as follows:

Group name: Each press of [Ctrl] + [G] sorts the list by group name, ascending or descending order.

Station name: Each press of [Ctrl] + [N] sorts the list by station name, in ascending or descending order.

Comm. type: Each press of [Ctrl] + [T] sorts the list by communication type, in ascending or descending order.

11. Press the [Enter] key to close the window.

12. For e-mail following a)-d) below. For other communication formats, go to step 13.

a) Press the [↓] key to choose Subject.

b) Press the [Enter] key to show the title window.

c) Type title.

d) Press the [Enter] key to close the window.

13. Press the [↓] key to choose LES ID.

14. Press the [Enter] key to display the LES List.

15. Press the [↓] or [↑] key to choose an LES.

16. Press the [Enter] key to close the window.

17. Press the [↓] key to choose Activation.

18. Press the [Enter] key to open the activation options window.

19. Press the [↓] or [↑] key to choose "Regular Interval" or "Daily" as appropriate.

20. Press the [Enter] key to close the window.

21. Do one of the following depending on the selection you made at step 19.

"Regular Interval" selected at step 19

(1) Press the [↓] to choose Interval Time.

(2) Press the [Enter] key to open the interval time entry window.

(3) The interval should be at least 10 minutes.

(4) Press the [Enter] key to close the window.

(5) Press the [↓] key to choose Report Times.

(6) Press the [Enter] key to open the report times entry window.

(7) Key in the report times, or press the [Back Space] key to display "---" to choose "No Limit" to transmit data until the "Status" setting is turned OFF.

(8) Press the [Enter] key to close the window.

5. DATA REPORTING AND POLLING

“Daily” is selected at step 19

- (1) Press the [↓] to choose Start Time 1.
- (2) Press the [Enter] key to open the start time entry window.
- (3) Key in the start time.
- (4) Press the [Enter] key to close the window.
- (5) If necessary, key in the start time of Start Times 2-4.

22. Press the [↓] key to choose Report Contents.

23. Press the [Enter] key to open the report contents options window.

24. Press the [↓] or [↑] key to choose the contents of message report and press the [Enter] key to close the window.

NAV: Position, speed, course

NAV(R): Position, speed, course. The difference between this and “NAV” above is that blank areas in data are shortened to lessen toll charge.

FILE: Choose a file. (When chosen “FILE” is activated. Choose file with cursor and press the [Enter] key.)

25. Press the [Esc] key to show the update window.

Message Report	
PIN Code	
Message Report Programming	
Status	ON
Station Name	FRNINMBTSTSES
Destination Type	TELEX
Prefix Code	
Country/Ocean Code	583
Station ID	343199710
Modem Type	
Subject	
LES ID	303 (KDDI)
Activation	Daily
Interval Time	01:00
Report Times	24 (--- : No Limit)
Start Time1	08:00
Start Time2	
Start Time3	
Start Time4	
Report Contents	NAV
File	

Update

Yes | No

Message report screen

26. Yes is selected; press the [Enter] key.

27. Press the [Esc] key twice to return to the standby display.

5.1.3 Automatic printing of data report, polling command

Data reports and polling commands are automatically printed, in the default state. If you do not require automatic printing of data reports or polling commands do the following:

1. Press the [F8] key to open the Setup menu.
2. Press the [5] key to choose Auto Mode Setup.

Auto Mode Setup	
Auto Log Print	OFF
Receive Alarm	OFF
Auto Receive Message Save	OFF
Auto Receive Message Print	OFF
Data Report & Polling Print	OFF
Auto EGC Message Save	
Auto EGC Message Print	

Auto mode setup menu

3. Press the [↓] or [↑] key to choose Data Report & Polling Print.
4. Press the [Enter] key to open the options window.
5. Press the [↓] key to choose OFF. (Choose ON for automatic printing of data report and polling command.)
6. Press the [Enter] key to close the window.
7. Press [Esc] key twice.

5.2 Polling

When the FELCOM 16 receives a polling command from your home office it automatically transmits data to your home office. The data are position, speed, bearing and other data sent from a navigator or an interface unit.

A polling command from your home office can also activate a data report or message report if the corresponding setting is completed on the FELCOM 16. If a polling command with a file name is received, the FELCOM 16 transmits the file to your home office.

5.2.1 Polling commands

This paragraph shows you how to make the polling command at your home office.

There are two kinds of polling commands: one is sent on the MES signalling channel and the other is sent on the MES message channel.

¥

Polling command on MES signalling channel

Request a land station to make the polling command because the format varies with land station.

Polling command on MES message channel

To make the polling command, enter D???, hyphen, PIN code (max. 8 digits), hyphen, file name, colon.

To send file data, type a hyphen and file name. Then, only the file specified in the directory of the Message Directory is transmitted. If neither hyphen nor file name is entered, nav data (own ship position, course, speed, etc) is transmitted. For PIN Code setting, refer to the next page.

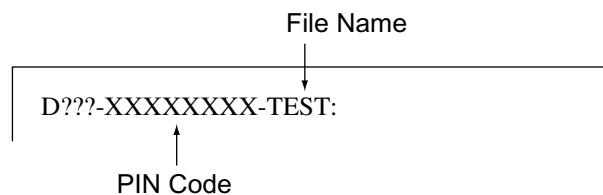

Polling command

If the above polling command PIN code and the PIN code set on the message report menu (see next page) are the same, data is sent to the subscriber set on the message report menu.

◆ PIN Code

The PIN (Personal ID Number) code is an eight-digit code number agreed upon by communicating parties, and there is no rule for determining PIN code. It is a password used in message reporting. When a ship receives a polling command w/PIN code from a shore subscriber and the code matches that of the ship, the ship sends a message report.

To register PIN code number do the following:

1. Press [F5] to show the Report menu.
2. Press the [2] key to open the Message Report menu.
3. Press [1], [2], [3] or [4] key to show the following menu.

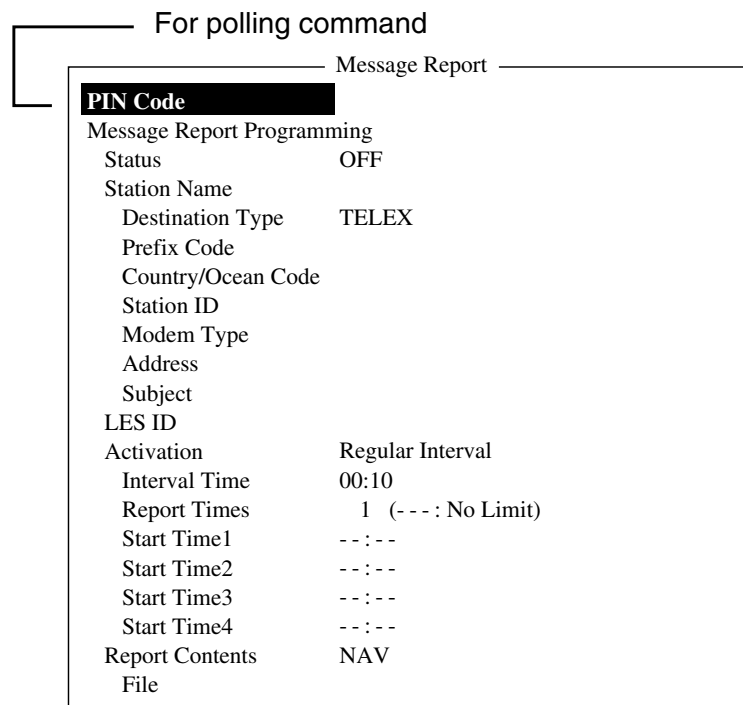

Message report menu

4. PIN Code is selected; press the [Enter] key to open the PIN code entry window.
5. Enter PIN code number (max. 8 digits).
6. Press the [Enter] key.
7. Follow from step 4 on page 5-4.

5.2.2 Other polling commands

Telex

P???:PIN Code/TELEX/LES number/Country number/Subscriber's number/File name:

E-mail

P???:PIN Code/EMAIL/LES number/ E-mail address/File name:

Public Switched Telephone Network

P???:PIN Code/PSTN/Modem type/LES number/Country number/Subscriber's number/File name:

Modem type is selected from T30, V21, V22B, V22, V23, V26B, V26T, V27T or V32.

Packet Switched Data Network

P???:PIN Code/PSDN/LES number/Country number/Subscriber's number/File name:

Data Network Identification

P???:PIN Code/DNID/LES number/Subscriber's number/File name:

Facsimile

P???:PIN Code/FAX/LES number/Country number/Subscriber's number/File name:

Telex service

P???:PIN Code/SPEC/LES number/Country number/Subscriber's number/File name:

For ship-to-ship communication, country number is ocean region number.

Subscriber's number includes Station ID, Telex ID, etc.

If file name is not specified (P???:PIN Code/~ /Subscriber's Number), the FELCOM 16 sends ship's position, speed and course.

For example, you transmit polling command to MES of PIN code 12345678 via KDDI station (Pacific Ocean: 203) specifying telex number 720-5644325. Then, that MES transmits position, speed, bearing, water temperature, current and depth.

P???:/12345678/TELEX/203/720/5644325/:

To have other MES transmit position, speed and bearing by e-mail to abc@furuno.co.jp, for example, use the following command.

P???:/12345678/EMAIL/203/abc@furuno.co.jp:

5.3 DNID (Data Network Identification)

Group data exchange (polling, data reporting) is available by registering with an LES which provides such services. When you make a contract with an information provider, DNIDs are downloaded from the information provider to your FELCOM 16, via the appropriate LES.

Up to 64 DNIDs can be downloaded to the FELCOM 16. You can see which DNIDs are stored as below.

5.3.1 Displaying DNID

It is necessary to contract with an LES to exchange data within a group. The LES sends a DNID (Data Network Identification) number to each member of the group. The FELCOM 16 can store 64 DNIDs.

1. Press the [F5] key to display the Reports menu.
2. Press the [3] key to display the Data Network ID list.

No.	Act	DNID	LES	Subaddr	Member	Text
01	*	00004	101	000	001	
02	*	00004	101	002	003	
03	*	23456	101	002	223	
04	*	03333	101	002	044	
05	*	03333	101	000	044	
06	*	07777	101	000	099	
07	*	09999	101	000	088	
08						
09						
10						

Mark '*' means activation. Ctrl+P: Print

* DNID effective

Data network ID list

Note: Asterisk-marked DNIDs are available for use.

5.3.2 Enabling/Disabling DNID

DNID can be enabled or disabled as follows:

1. Press the [F5] key followed by the [3] key to show the Data Network ID list.
2. Press the [↓] or [↑] key to choose desired DNID from the data network ID list.
3. Press the [Enter] key to enable or disable the DNID as appropriate. An asterisk appears next to the DNID when it is enabled.

Note: If a DNID is disabled during data reporting, “running data program (poll)” is displayed and polling is cancelled.

4. Press the [Esc] key twice to return to the standby display.

5. DATA REPORTING AND POLLING

(This page intentionally left blank.)

6. OTHER FUNCTIONS

This chapter describes how to abort operation, scan NCS, choose EGC and NCS channels and display LES information.

6.1 Aborting an Operation

You can abort transmission, receiving or scanning (on the NCS common channel) as follows:

1. Press the [F7] key to display the Options menu.

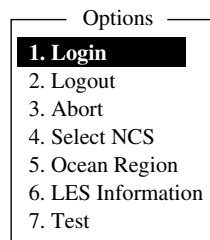

Options menu (when FELCOM 16 functions as Inmarsat MES)

2. Press the [3] key to choose Abort.

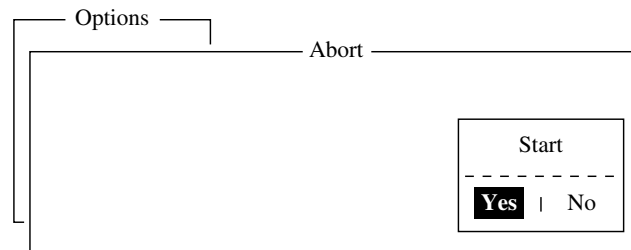

Abort screen

3. Yes is selected; press the [Enter] key to abort current operation.
The message "FORCED CLEARING" replaces "SENDING" or "RECEIVING" at the bottom of the screen. When the process has been aborted, the message "Process Aborted. Press any key to escape." appears.

Note: If aborting is attempted in modes other than those mentioned above, the message "Ignored: Can not abort current process." appears.

6.2 Scanning NCS Common Channel

When “unsync” condition (UNSYNC displayed at bottom center of the screen) continues for six minutes and error rate in received message is greater than 80% (BBER indication reads more than 80), choose suitable ocean region. Note that the FELCOM 16 must be IDLE and the MES mode must be INMARSAT C in order to scan common channel.

If the FELCOM 16 is not idle the message “Ignored: MES is not idle” is displayed. Press any key to erase the message and then wait until the equipment is in idle state.

1. Press the [F7] key to display the Options menu.
2. Press the [5] key to display the Ocean Region menu.

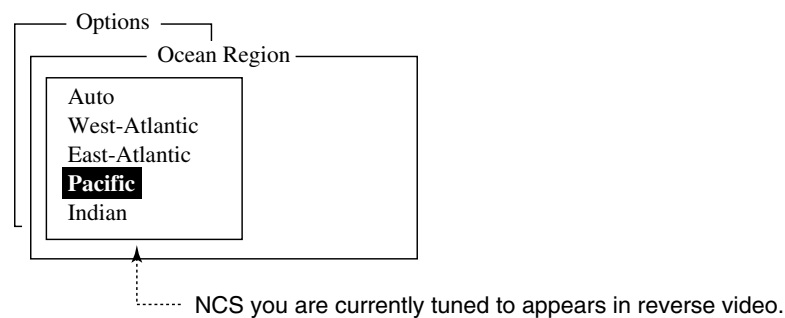

Ocean region menu

3. Press the [↓] or [↑] key to choose another NCS and press the [Enter] key. If Auto is selected, FELCOM 16 scans all ocean regions in turn.

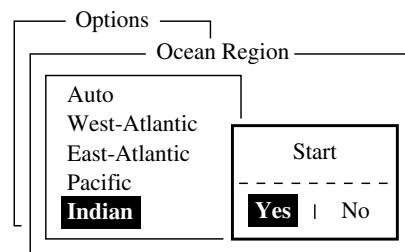

NCS scan confirmation screen

4. Yes is selected; press the [Enter] key to start the scanning.
The message “Starting Scan Process. Press any key to escape.” appears during the scanning.
5. Press the [Esc] key twice to return to the standby display.

6.3 Choosing EGC Receiving Channel

EGC channel can be selected when the terminal unit is set to operate as an EGC-only receiver. However, this procedure is shown for reference only; currently there is only one EGC channel per NCS.

1. Press the [F7] key to display the Options menu.

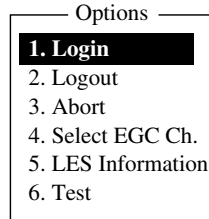

Options menu (when FELCOM 16 functions as EGC receiver)

2. Press the [4] key to choose Select EGC Ch.

```

EGC Channel List
-----
ENTER: Set  ESC: Quit
-----+-----+-----+-----
11080* | 12580* | 10840* | 11088*
-----+-----+-----+-----
|         |         |         |
|         |         |         |
|         |         |         |
|         |         |         |
  
```

EGC channel list

3. Choose desired channel and then press the [Enter] key.
4. Press the [Esc] key to return to the standby display.

6.4 Choosing NCS Channel

You may select NCS common channel as shown below. Currently, each satellite transmits one global beam. In the future, the satellites will transmit multiple spot beams, namely, the NCS will have multiple channels.

The below procedure is provided for reference.

1. Press the [F7] key to display the Options menu.
2. Press the [4] key to display the NCS Channel List.

Options

1. Login

NCS Channel List

ENTER: Set ESC: Quit

No	AOR (WEST)		AOR (EAST)		POR		IOR	
	ID	FREQ	ID	FREQ	ID	FREQ	ID	FREQ
01	044	11080*	144	12580*	244	12580*	344	10840*
02	0		1		2		3	
03	0		1		2		3	
04	0		1		2		3	
05	0		1		2		3	
06	0		1		2		3	
07	0		1		2		3	
08	0		1		2		3	

NCS channel list

3. Choose desired channel and then press the [Enter] key. Then, the FELCOM 16 starts to synchronize with the NCS channel selected.
4. Press the [Esc] key to return to the standby display.

6.5 LES Information

Each time you log in LES data is automatically downloaded through the NCS common channel to the FELCOM 16, and saved to the LES Information display. You may view this display as follows:

1. Press the [F7] key to show the Option menu.

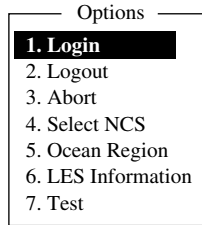

FELCOM 16 functions as Inmarsat MES

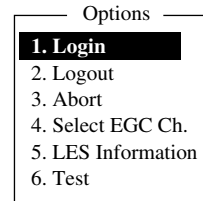

FELCOM 16 functions as EGC receiver

Options menu

2. Press the [6] key (Inmarsat MES) or [5] key (EGC receiver) to show the LES Information display.

From left in order B8 to B1

LES ID Name		Status	Services	TDM Ch.
201	Telenor S.S.Inc	11111000	AS----EL	11982
202	Stratos M.N.	11111000	AS----EL	11826
203	KDDI	11111000	AS----EL	11806
204	Telenor S.S.AS	11111000	AS----EL	11762
208	Korea Telecom	11111000	AS----EL	11778
210	Singapore T.	11111000	AS----EL	11842
211	Beijing Marine	11111000	AS----EL	11754
212	Xantic (NED)	11111000	AS----EL	11802

From left in order 1B8 to 1B1, 2B8 to 2B1
If bit is 1 alphabet is displayed.

LES information display

3. Use the [↑] or [↓] key to scroll the list.
4. Press the [Esc] key twice to return to the standby display.

Description of LES information table

Bit No.	Status	Flag	Meaning
B8	Return link speed	1	600 bps
		0	300 bps
B7	Operational or spare satellite operation	1	Operational
		0	Spare
B6	LES status	1	In service
		0	Out of service
B5	LES status	1	Clear
		0	Congested
B4	Used only by land earth stations	1	Terrestrial links open
		0	Terrestrial links closed
B3-1	Spare		

6. OTHER FUNCTIONS

Services:

Alphabet shown only when Flag is "1" for a bit.

Bit No.	Flag	Meaning	Display
1B8	1	Maritime distress alerting	A
	0	No Maritime distress alerting	None
1B7	1	SafetyNET traffic	S
	0	No SafetyNET traffic	None
1B6	1	Inmarsat-C traffic	C
	0	No Inmarsat-C traffic	None
1B5	1	Store and Forward	T
	0	No Store and Forward	None
1B4	1	Half Duplex	H
	0	No Half Duplex	None
1B3	1	Full Duplex	D
	0	No Full Duplex	None
1B2	1	Closed Network	N
	0	No Closed Network	None
1B1	1	FleetNET Traffic	F
	0	No FleetNET Traffic	None
2B8	1	Prefixed store and forward message supported	P
	0	Prefixed store and forward message not supported	None
2B7	1	Land mobile alerting	Not used
	0	No Land mobile alerting	
2B6	1	Aero-C service supported	
	0	Aero-C service not supported	
2B5	1	ITA2 transmission supported	I
	0	ITA2 transmission not supported	None
2B4	1	Data transmission supported	B
	0	Data transmission not supported	None
2B3	1	Basic X.400 supported	X
	0	Basic X.400 not supported	None
2B2	1	Enhanced X.400 supported	E
	0	Enhanced X.400 not supported	None
2B1	1	Low power C MES supported	L
	0	Low power C MES not supported	None

TDM Ch.: TDM channel used by LES to transmit.

7. MAINTENANCE, TROUBLESHOOTING

This chapter provides the information necessary for the maintenance and checking of the FELCOM 16. Please read the safety information at the beginning of this manual before attempting any maintenance procedure.

7.1 General Checking and Maintenance

Turn off the power before conducting any maintenance procedures other than the cleaning of the communication unit.

Cleaning the communication unit

Dust and dirt can be removed from the communication unit with a soft, dry cloth. DO NOT use chemical cleaners. They may remove paint and markings or deform the equipment.

Checking connectors and earth terminal on the communication unit

Check that the connectors and earth terminal on the communication unit are tightly fastened. If the copper strap (earth material) has rusted, clean it.

When the power can't be turned on

When the communication unit cannot be turned on do the following:

- Check that the power cable connector on the rear panel of the communication unit for tightness.
- Check if the ship's mains switchboard is turned on.
- Have a qualified technician check the power voltage at the power connector on the rear of the communication unit.

7.2 Diagnostics

The system is equipped with a diagnostic test which check it for proper operation.

7.2.1 Self test at power on

The terminal unit performs the ROM sum check and RAM read and write test when turned on. If the test results are normal the equipment goes into standby. If error is found you cannot transmit. Contact your dealer for advice.

7.2.2 Testing the communication unit through the keyboard, displaying program version no.

The communication unit must be idle to execute the test.

1. Press the [F7] key to display the Options menu.

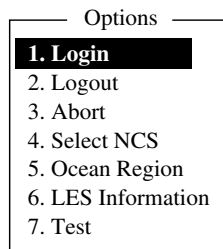

FELCOM functions as Inmarsat MES

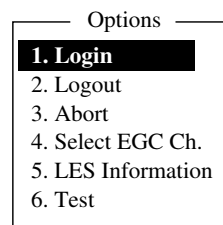

FELCOM functions as EGC receiver

Options menu

2. Press the [7] key ([6] key if the FELCOM 16 functions as an EGC receiver) to display the Test menu.

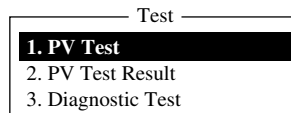

Test menu

3. Press the [3] key to choose Diagnostic Test.

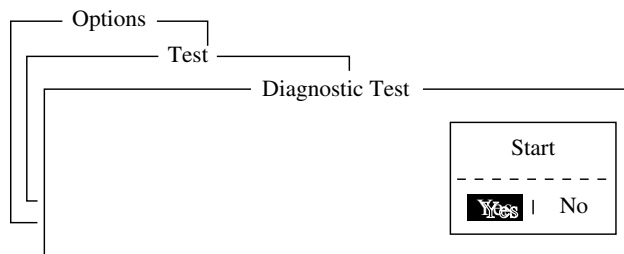

Start window

4. Yes is selected; press the [Enter] key to start the test. The message “Now testing” (flashing) appears during the testing.

When the test is completed, the screen shows the test results as shown at the top of the next page.

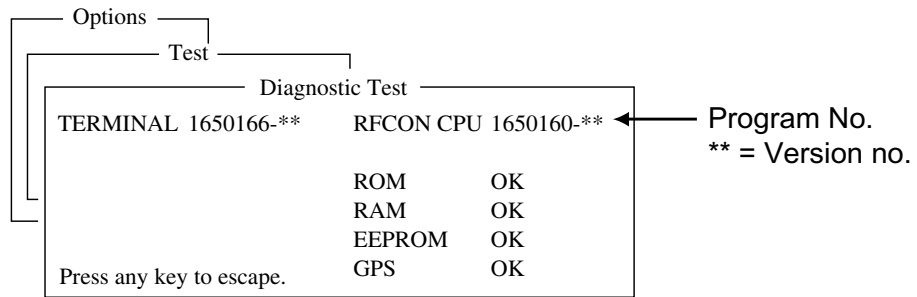

Sample communication unit self test results

The results are shown as OK or NG (No Good). For any NG, contact your dealer for advice.

5. Press the [Esc] key to stop the test and return to the Test menu.

Note: Diagnostic test-related error messages appear at the bottom of the screen as follows: TROUBLE: RFCON CPU ROM NG, TROUBLE: RFCON CPU RAM NG, TROUBLE: RFCON CPU EEPROM NG

7.3 Performance Verification (PV) Test

After the FELCOM 16 is installed, the installer usually confirms that it is functioning properly, by logging in and conducting the PV test. This test consists of the receiving a test message from an LES, transmitting a message to an LES and a distress alert test.

The results of the test appear on the PV test result display.

The PV test cannot be conducted from an auxiliary terminal unit. Note that the test can also be initiated by an NCS.

7.3.1 PV test sequence

1. Choose PV Test from the Test menu.
2. The MES requests an NCS to conduct the PV test.
3. NCS acknowledges request for testing.
4. The MES, upon receiving acknowledgment from NCS, goes into pending state.
5. NCS will choose an LES to perform the test.
6. The LES transmits a test message to the MES.
7. The MES transmits a test message to the LES.
8. The LES receives test message.
9. The MES automatically transmits the distress alert test within two minutes after completion of step 8.
10. When the distress alert test is finished, the LES sends the results of the PV test to the MES.

7.3.2 PV test procedure

1. Confirm that the communication unit is in idle condition and logged in.
2. Press the [F7] key to display the Options menu.
3. Press the [7] key to choose Test.
4. Press the [1] key to choose PV Test.

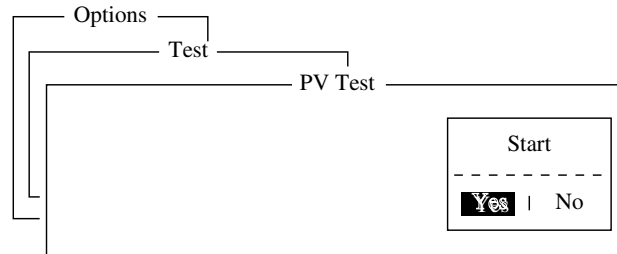

PV test screen

5. Yes is selected; press the [Enter] key to transmit the PV test request to NCS.

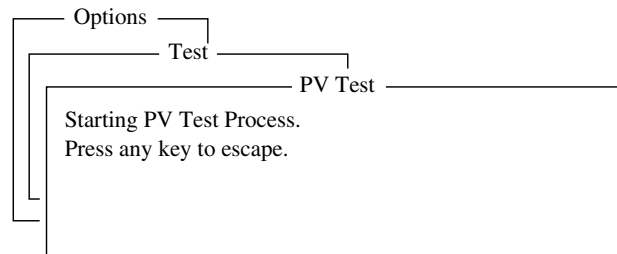

PV test screen

Note: If the terminal unit is not idle when the test is initiated, the screen displays “Ignored: MES is not idle now. Cannot start PV Test.” And if you are not logged in, “Ignored: MES is not Login. Please operate Login.” appears.

6. Press the [Esc] key to return to the standby display.
7. The (automatic) testing sequence is as follows:
 - a) The screen displays “Current State: Idle (pending!)” when you receive the acknowledge signal from the NCS.
 - b) When preparations for testing have been completed, “Current State: TESTING” appears at the bottom of the screen. Further, the following message appears.

Automatic test mode: Normal communication disabled.
Do not press any distress button unless you are in distress.

- c) Receive a message from the LES. Send a test message to the LES.
 - d) Then, the distress alert test is automatically conducted after you have sent a test message. Do not operate the equipment at this time.
 - e) When testing has been completed, “Current State: IDLE” appears at the bottom of the screen.
8. The test results appear on the PV Test Result screen. See the next section for how to interpret the results.

7.3.3 Results of PV test

1. At the standby display, press the [F7] key to display the Options menu.
2. Press the [7] key to display the Test menu.
3. Press the [2] key to display the results of the PV test.

The diagram shows a sequence of three overlapping rectangular boxes representing the menu structure. The top box is labeled 'Options', the middle box is labeled 'Test', and the bottom box is labeled 'PV Test Result'. Arrows indicate the flow from 'Options' to 'Test' and from 'Test' to 'PV Test Result'.

PV Test Result		Ctrl+P: Print ESC: Quit
Test Date & Time	02-02-25 01:58 (UTC)	
Attempts	First attempt	
BBER	Pass	
Shore-to-Ship Attempts	First attempt	
Ship-to Shore Attempts	First attempt	
Distress Alert	Pass (Test OK)	
Signal strength	Pass (Greater than Std level + 10dB)	
Overall Result	Pass (Applicable tests pass)	

Sample PV test results

4. To return to the standby display, press any key.

Interpreting the PV test results display

Test Date & Time:	Date and time of test
Attempts:	Number of times the PV test was conducted.
BBER:	Bulletin Board Error Rate (%). "Pass" appears for no error.
Shore-to-Ship Attempts:	Number of tests initiated by LES.
Ship-to-Shore Attempts:	Number of tests initiated by MES.
Distress Alert:	"Pass (Test OK)" appears for successful testing.
Signal Strength:	"Pass" appears if signal strength is greater than standard level.
Overall Result:	"Pass" appears for satisfactory completion of the test.

7.4 System Status Monitor

The system status monitor, which is always displayed, provides date, time, equipment status and navigation data.

File	Edit	Transmit	EGC	Reports	Logs	Options	Setup	Position	StopAlarm
Date			02-02-25			BBER		IMN: 443156710	
Time			01:32 (UTC)			C/N		000	
Position			LAT 34:30.00N			Send Level		OK (0 dB)	
Waypoint			LON 135:00.00E			Rx AGC Level		OK (0)	
Course			LAT			REF Offset Freq		OK (254)	
Speed			LON			Synthe Local		OK	
Current NCS			345.5 DEG						
Current Channel			10.2 KTS						
Current TDM			344 (IOR) LOGOUT			Antenna Power Supply		OK	
MES Status			NCS CC			Water Temperature		DEG	
GPS Status			NCS CC			Water Current			
DCE Memory			Idle			Direction		DEG	
			2D			Speed		KTS	
			32818 Bytes free			Depth			
Current State: IDLE				Retuning		02-02-25 01:32 (UTC)			
DCE F16 Ver. ##				NCS: IOR LOGOUT		LAT: 34:30.00N			
						LON: 135:00.00E			

= Version no. of RF CON Board

System status monitor display

Interpreting the system status monitor

Date:	Current date
Time:	Current time
Position:	Own ship's L/L position (either manual entry or automatic input by navigator)
Waypoint:	Blank
Course:	Course
Speed:	Ship's speed
Current NCS:	NCS your vessel is logged in with
Current Channel:	Channel in use
Current TDM:	Channel TDM
MES Status:	Operational status of MES
GPS Status:	Receiving signal status from GPS receiver.
	CST: Cold Start
	ACK: Acquired; Almanac data acquired
	IMP: Impossible; cannot receive GPS signal
	INT: Interrupted; object interfering with reception of GPS signal
	ALM: Receiving the almanac
	2D, 3D: Position-fixing method by 2D or 3D

DCE Memory:	Memory remaining in communication unit
BBER:	Bulletin Board Error Rate (%)
C/N:	Check of circuit status with LES, receiving circuit in antenna unit and RF CON/CPU Board in communication unit. OK appears for figure greater than 31.
Send Level:	TX level check. At transmission, OK appears for figure greater than 123. At reception, OK appears for figure lower than 32.
RX AGC Level:	Check of the receiving circuit of the antenna unit and the RF CON/CPU Board in the communication unit. OK appears for figure greater than 60.
REF Offset Freq:	OK appears for figure lower than 150.
Synthe:	Check of RF CON/CPU Board.
Antenna Power Supply:	NG appears for discontinuity or short in antenna cable. OK is shown if the antenna is receiving electrical power.
Temperature*:	Blank
Water Current*	
Direction:	Blank
Speed:	Blank
Depth*:	Blank

* = Requires data from appropriate sensor.

7.5 Replacing the Fuse

The fuse (12 VDC: 10A, 24 VDC: 5A) in the power cable protects the communications unit from overcurrent and reverse polarity. If the fuse blows, find out the case before replacing it. If it blows again after replacement, contact your dealer for advice. Be sure to use the correct fuse. Use of a wrong will damage the equipment and void the warranty.

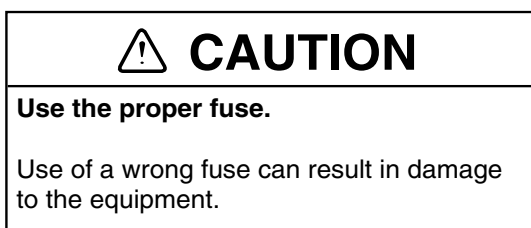

Fuse

12 VDC

Type: FGBO 10A AC125V

Code No.: 000-549-065

24 VDC

Type: FGBO 5A AC125V

Code No.: 000-549-064

7.6 Error Messages

This section describes the more commonly seen error messages and the means to restore normal operation. If normal operation cannot be restored, contact your dealer for advice.

7.6.1 Equipment trouble messages

Messages in this category are prefixed with "TROUBLE:".

Equipment trouble messages

Error Message	Meaning	Action
ANT power voltage abnormality.	Antenna power voltage.	Have a licensed radiocommunications technician check the set.
Carrier power level.	Carrier power level too high or too low.	Have a licensed radiocommunications technician check the set.
EEPROM ERROR.	EEPROM trouble.	Contact a FURUNO agent or dealer for advice.
Invalid MES ID, This equipment is defected. Please contact FURUNO.	MES ID is corrupted.	Have a licensed radiocommunications technician check the set.
Synthesizer UNLOCK.	Synthesizer unlock.	Have a licensed radiocommunications technician check the set.

7.6.2 Warning messages

Messages in this category are prefixed with "WARNING:"

Warning messages

Error Message	Meaning	Action
BBER over 80%. Scanning NCS start manually.	BBER (Bulletin Board Error Rate) exceeded 80%.	Select NCS manually.
Cannot enter new DNID. Memory full for DNIDs.	Memory for DNIDs is full.	Delete unnecessary DNIDs to enter new ones.
Cannot enter new ENID. Memory full for ENIDs.	Memory for ENIDs is full.	Delete unnecessary ENIDs to enter new ones.
Cannot find NCS CC in all region. Scanning is continued.	No NCS found in region.	Scanning automatically continues.
Cannot find NCS CC in preferred region. Scanning all region is started.	NCS could not be found in region selected. Scanning started to find NCS.	If NCS could not be found, contact you dealer for advice.
Internal GPS UNIT failure.	GPS signal could not be detected.	Internal GPS receiver may be damaged if this message appears frequently. Contact your dealer for advice.
Synchronization loss. Please change EGC channel.	Your station is not synchronized with selected EGC channel.	Change EGC channel.
Synchronization loss. Please check the current NCS.	Your station is not synchronized with selected NCS.	Change NCS.

APPENDIX

Menu Tree

F1: File

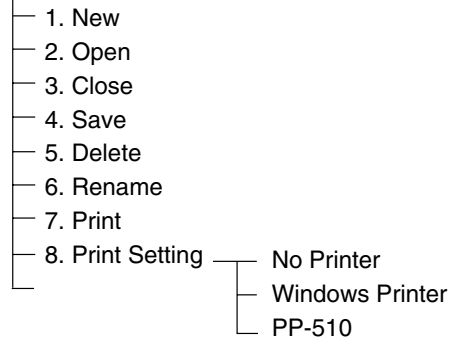

F2: Edit

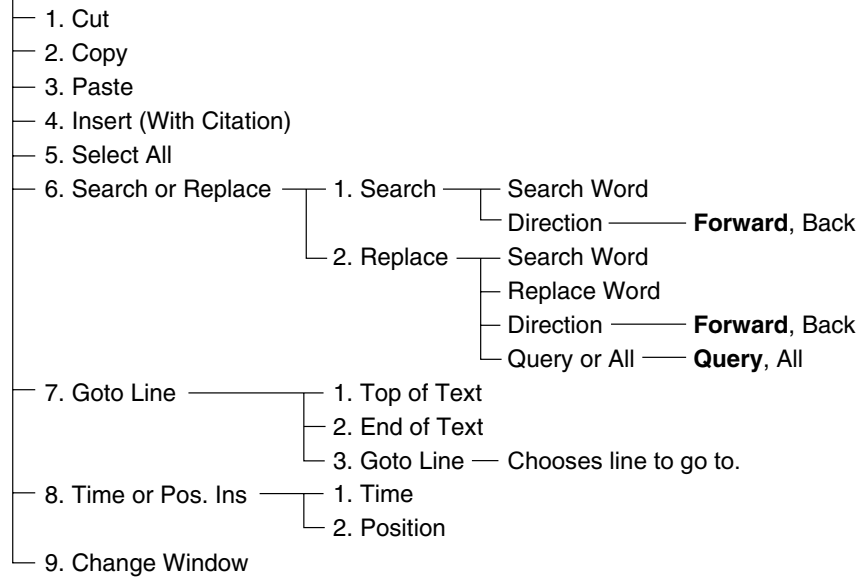

APPENDIX

F3: Transmit

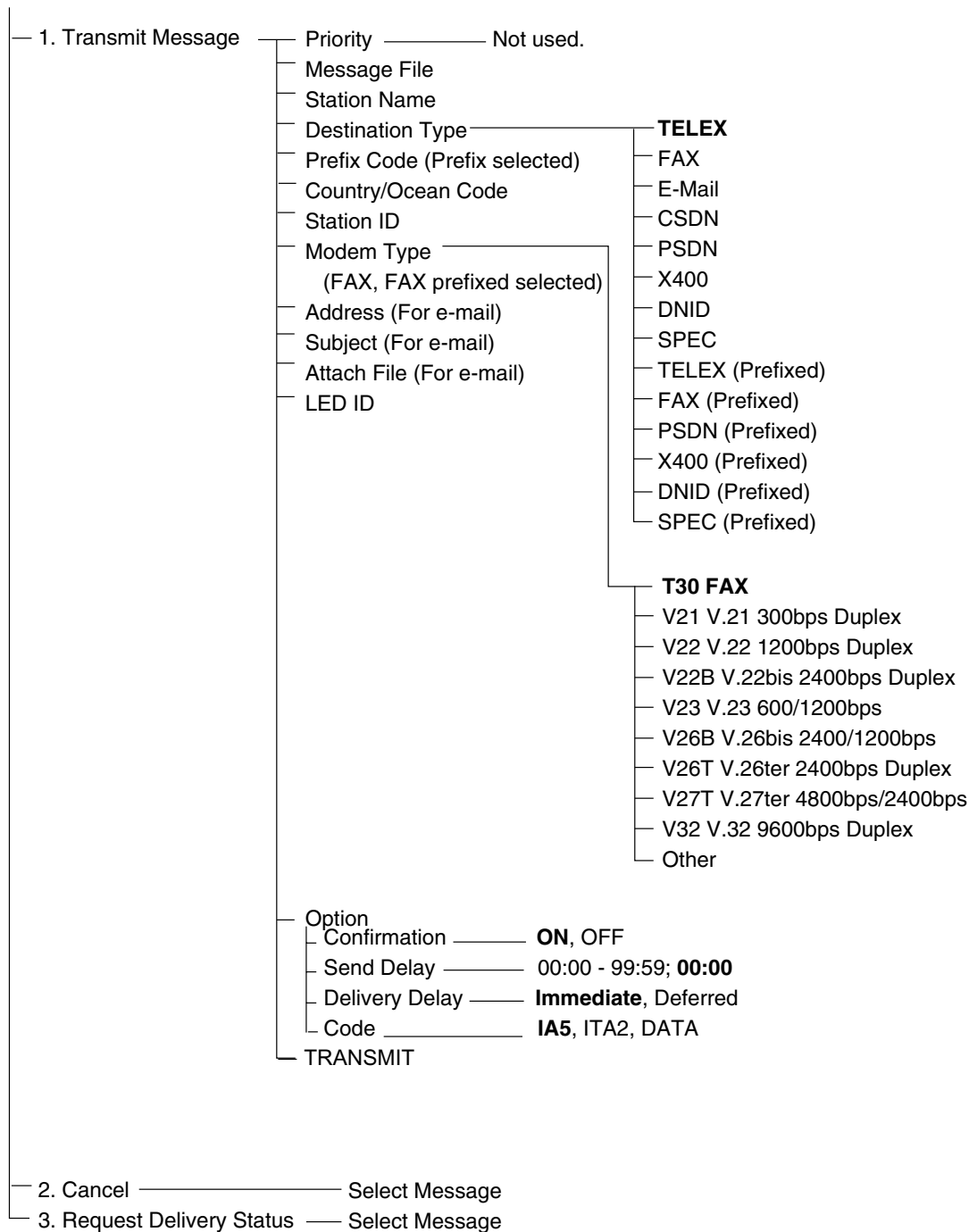

F4: EGC

- 1. Display EGC Message
- 2. EGC Network ID

F5: Reports

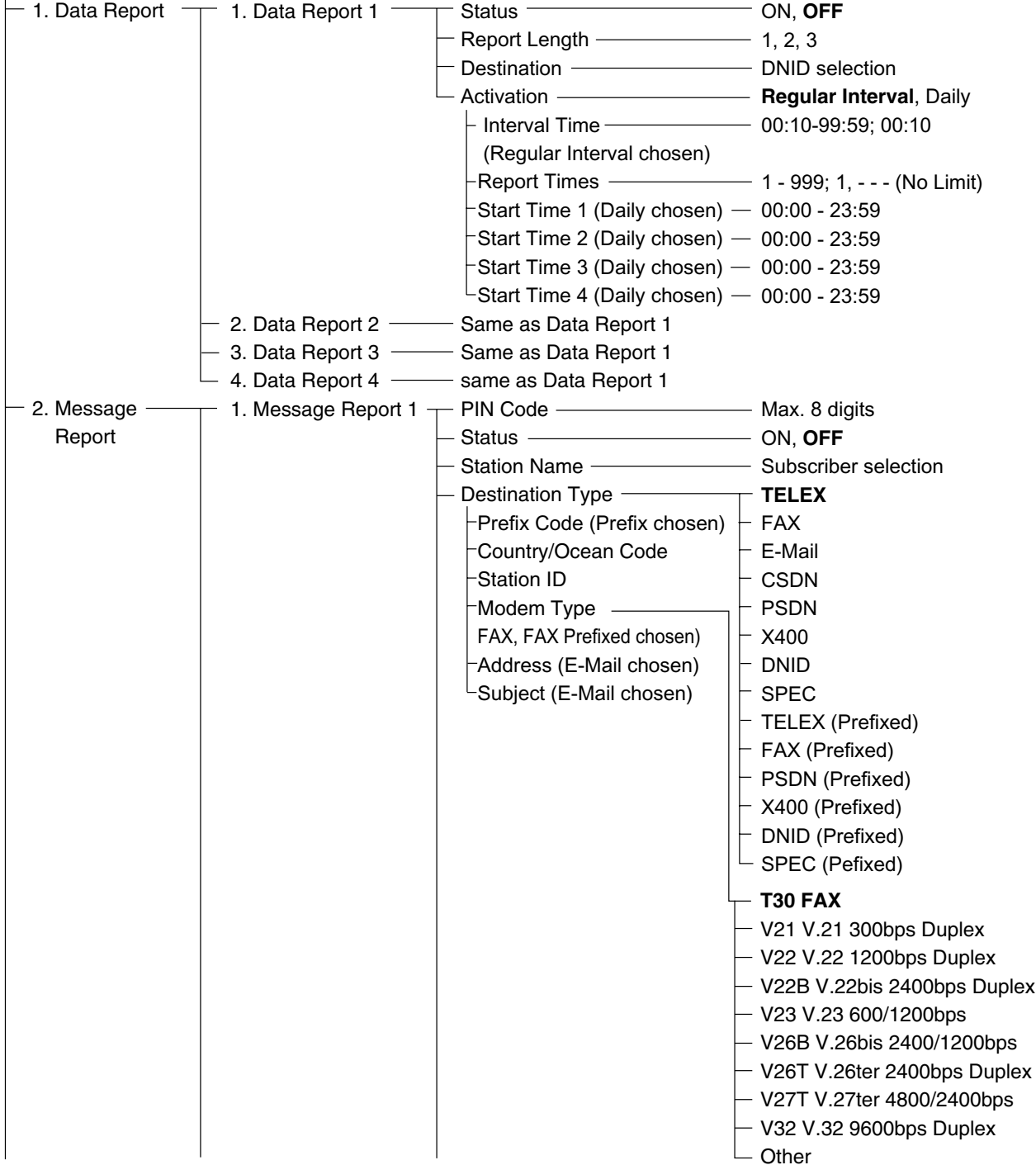

APPENDIX

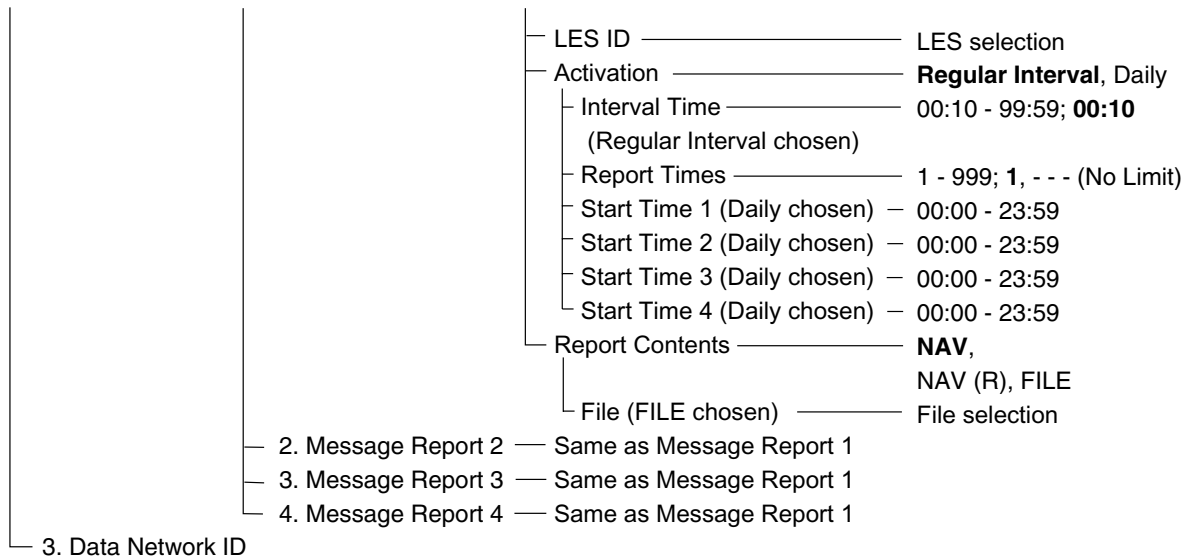

F6: Logs

- 1. Send Message Log
- 2. Receive Message Log
- 3. EGC Log
- 4. Log

F7: Options (FELCOM functions as Inmarsat MES)

- 1. Login — **Yes**, No
- 2. Logout — **Yes**, No
- 3. Abort — **Yes**, No
- 4. Select NCS
- 5. Ocean Region — **Auto**, West-Atlantic, East-Atlantic, Pacific, Indian
- 6. LES Information
- 7. Test
 - 1. PV Test — **Yes**, No
 - 2. PV Test Result
 - 3. Diagnostic Test — **Yes**, No

F7: Options (FELCOM functions as EGC receiver)

- 1. Login — **Yes**, No
- 2. Logout — **Yes**, No
- 3. Abort — **Yes**, No
- 4. Select EGC Ch.
- 5. LES Information
- 6. Test
 - 1. PV Test — **Yes**, No
 - 2. PV Test Result
 - 3. Diagnostic Test — **Yes**, No

F8: Setup

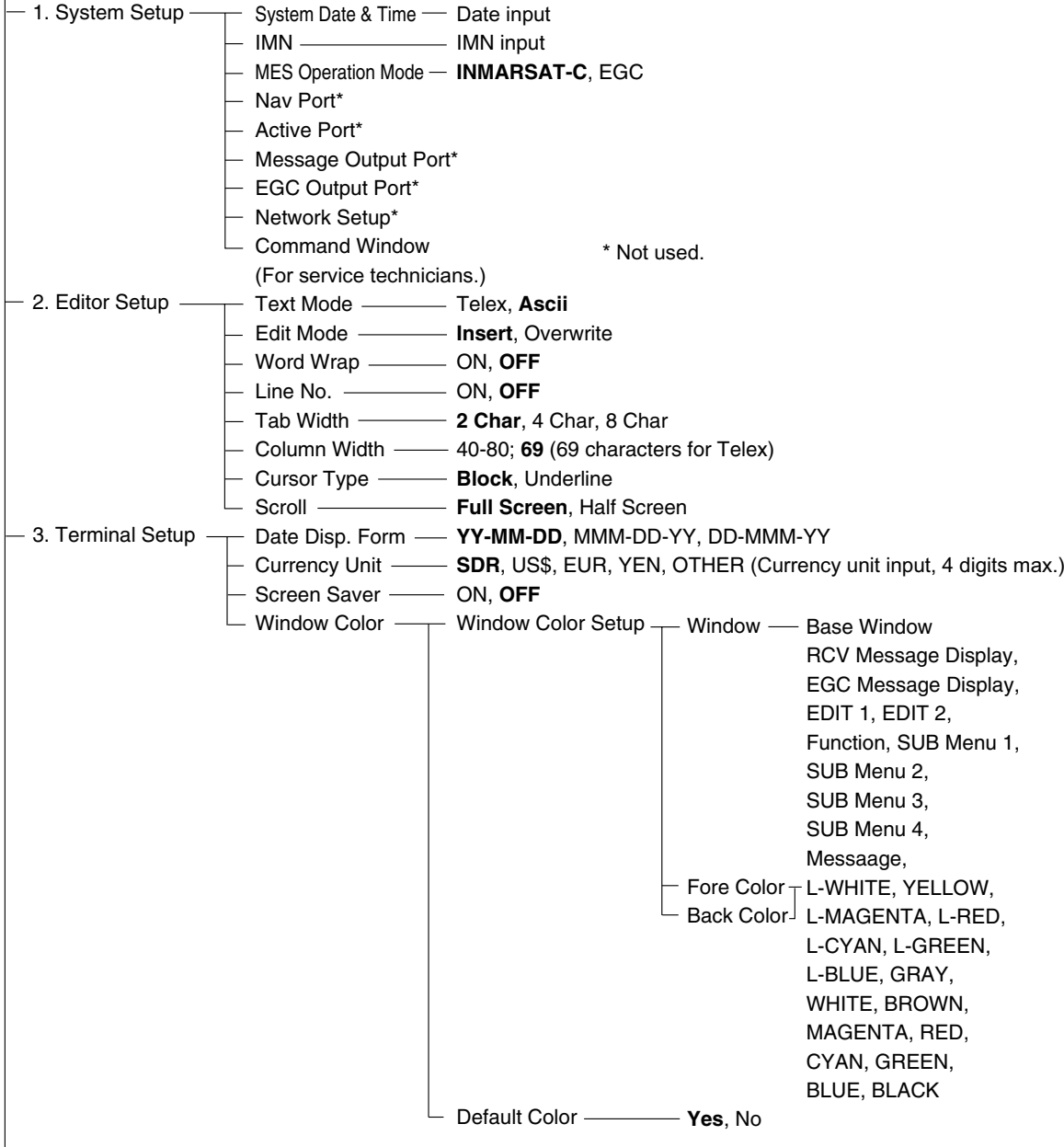

APPENDIX

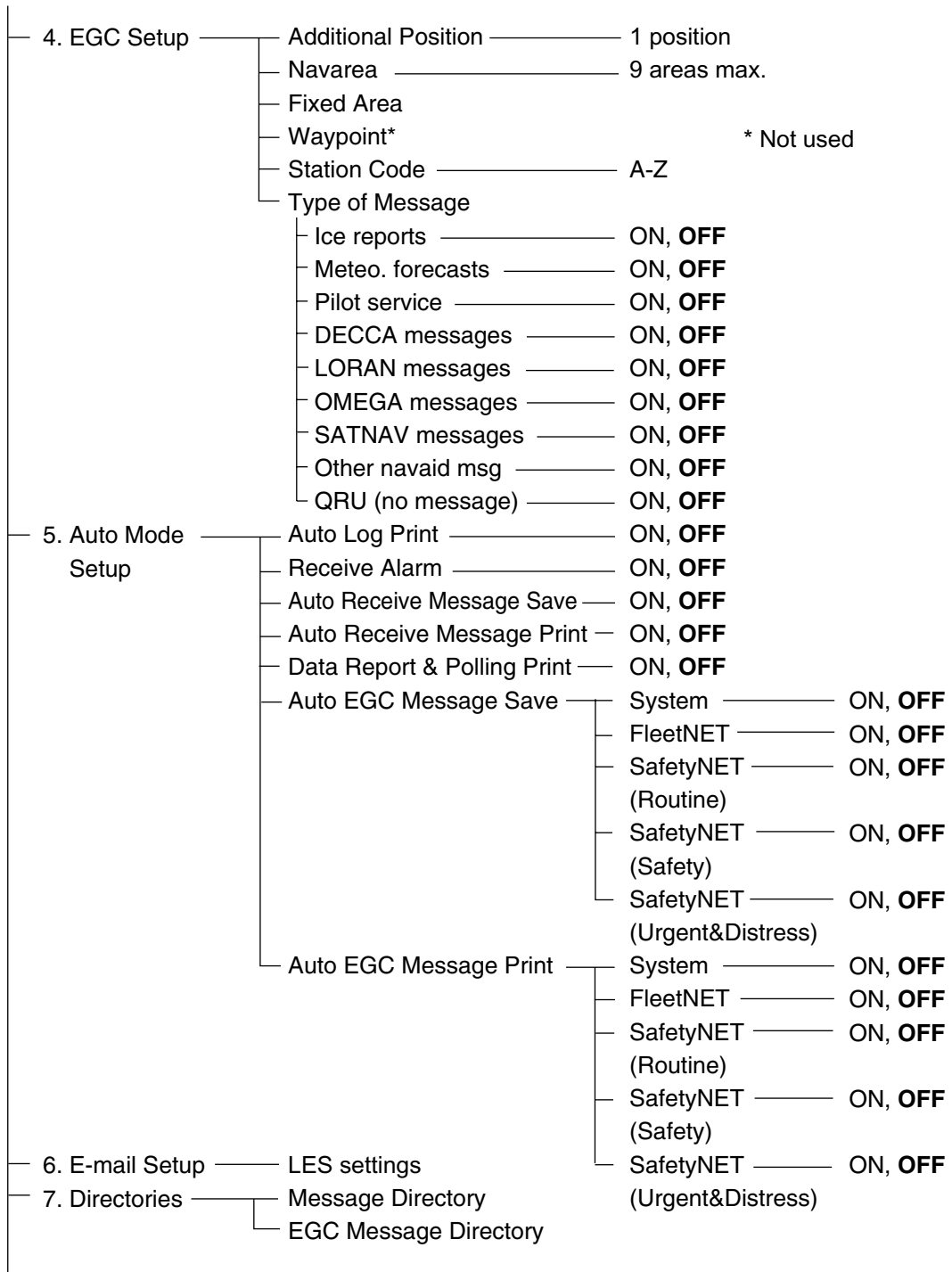

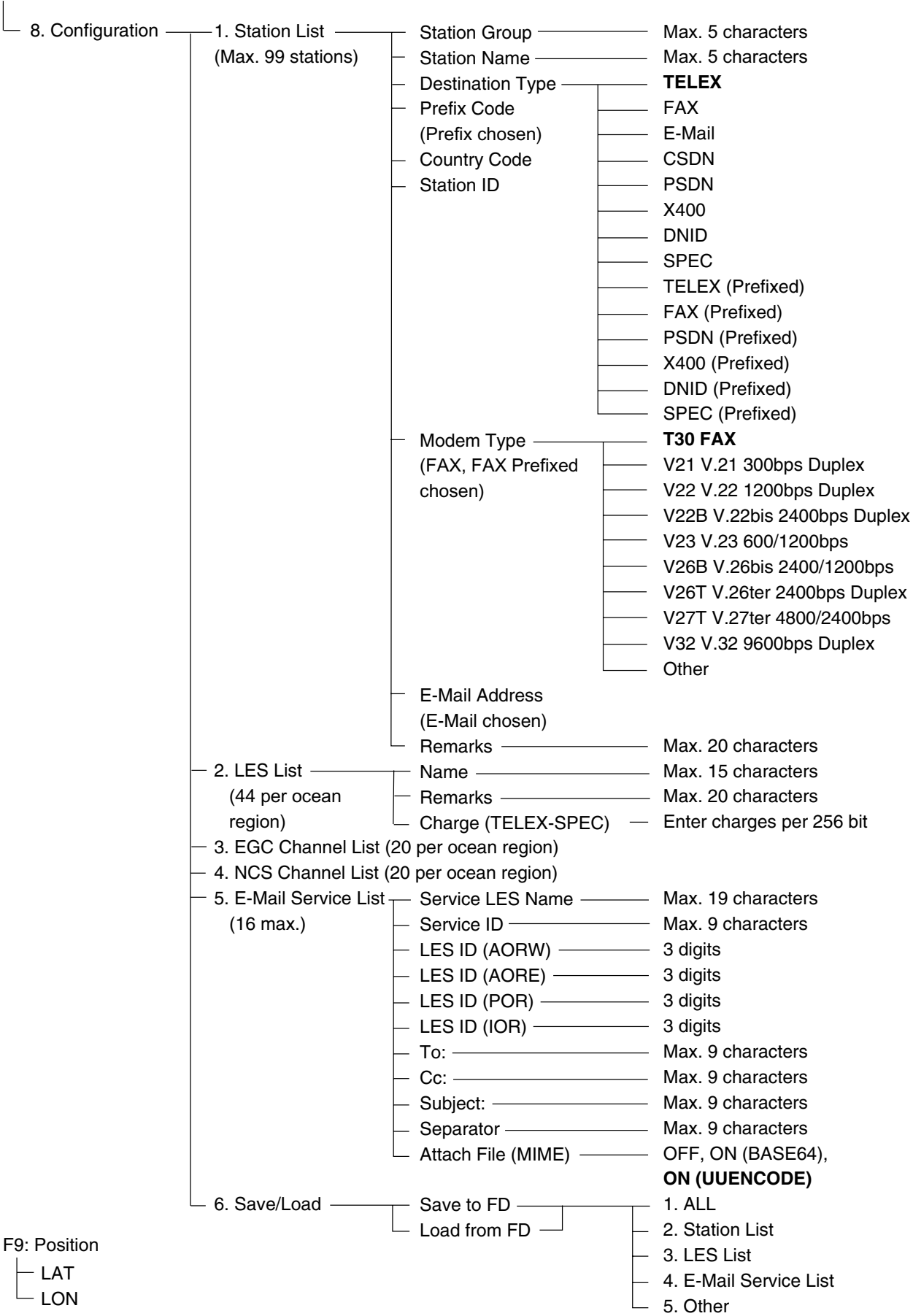

F9: Position
 |
 | LAT
 |
 | LON

F10: Stop Alarm

International Telex/Telephone Country Code List

Area and Country	Telephone Country Code	Telex Country Code	Remarks for Telex Code
Afghanistan	93	79	
Alaska	1	200	
Albania	355	604	
Algeria	21	408	
American Samoa	684	770	
American Virgin Is.	1	208	Telex calls to former WUI subscribers, insert the figure "9" after the destination code "208".
Andorra	33	590	
Angola	244	991	
Anguilla	1	391	
Antigua & Barbuda	2	393	
Argentina	54	33	Disregard the figure "0" at head of subscriber number.
Armenia	7	684	
Aruba	297	303	Subscriber numbers are 2XXX or 5XXX
Ascension	247	939	Manual calls 3XXX
Australia	61	71	
Australian External Territories	672	766	
Austria	43	47	
Azerbaijani	994	784	
Azores Is.	351	404	Destination code is the same as for Portugal.
Bahamas	1	297	
Bahrain	973	490	
Bangladesh	880	780	
Barbados	1	392	
Belarus	7	681	
Belgium	32	46	
Belize	501	371	
Benin	229	972	
Bermuda	1	290	
Bhutan	975	890	
Bolivia (Rep. of)	591	371	
Bolivia (ENTAL)		309	
Bosnia-Herzegovina	387	600	
Botswana	267	962	
Brazil	55	38	Disregard the figure "0" at head of subscriber number.
British Virgin Is.	1	292	
Brunei Darussalam	673	809	
Bulgaria	359	67	
Burkina Faso	226	978	
Burundi	257	903	

Area and Country	Telephone Country Code	Telex Country Code	Remarks for Telex Code
Cambodia	855	807	Kampuchea Rep.
Cameroon	237	970	
Canada	1	{ 21	Disregard the figure "0" at head of subscriber number.
		{ 26	
Canary Is.	34	52	Destination code is the same as for Spain.
Cape Verde	238	993	
Cayman Is.	1	293	
Central Africa Rep.	236	971	
Chad	235	976	
Chile	56	34	{ TCH subscribers 2XXXXX ENTEL subscribers 5XXXXX TRA subscribers 3XXXXX TECOM subscribers 6XXXXX VTR CM subscribers 4XXXXX
China	86	85	
Christmas Is. (Aus)	672	766	
CIS (formerly USSR)	7	64	
Cocos-Keeling Is.	672	766	
Colombia	57	35	Disregard the figure "0" at head of subscriber number.
Comoros	269	994	Manual calls
Congo	242	981	
Cook Is.	682	772	
Costa Rica	506	376	
Cote d' Ivoire	225	983	Ivory Coast
Croatia	385	599	
Cuba	53	28	
Cyprus	357	605	
Czechoslovakia	42	66	
Denmark	45	55	
Diego Garcia	246	938	
Djibouti	253	979	
Dominica	1	394	
Dominican Rep.	1	{ 201	RCA subscribers 4XXXXX
		{ 202	For subscriber number beginning with 346, disregard "346" at head of subscriber number.
		{ 241	AGEM IR subscribers 61XX
Ecuador	593	308	
Egypt	20	91	
El Salvador	503	373	
Estonia (formerly USSR)	372	537	
Ethiopia	251	980	

APPENDIX

Area and Country	Telephone Country Code	Telex Country Code	Remarks for Telex Code
Falkland Is. (Malvinas)	500	306	
Faroe Is.	298	502	
Fiji	679	701	
Finland	358	57	
France	33	42	
French Guiana	594	300	
French Polynesia	689	702	
Gabon	241	973	
Gambia	220	996	
Georgia	7	683	
Germany (Fed, Rep. of)	49	{ 69	formerly East Germany
	49	{ 41	formerly West Germany
Ghana	233	94	
Gibraltar	350	405	
Greece	30	601	
Greenland	299	503	
Grenada	1	395	
Guadeloupe	590	299	
Guam (RCA)	671	700	
Guatemala	502	372	
Guiana	594	300	
Guinea Conakry	224	995	Manual calls
Guinea Bissau	245	969	
Guyana	592	295	
Haiti	509	203	RCA subscribers 9XXX
Hawaii	1	{ 704	RCA subscribers 8XXX or 2968XX
		{ 705	ITT subscribers 743XXX
		{ 708	WUI subscribers 63XXX or 63XXXX
		{ 709	WUH subscribers 39XXXX
		{ (773)	Telex calls to HTC subscribers can be made using Semi-automatic calls.
Honduras	504	374	
Hong Kong	852	802	
Hungary	36	61	
Iceland	354	501	
India	91	81	
Indonesia	62	73	Disregard the figure "0" at head of subscriber number.
Iran	98	88	
Iraq	964	491	
Ireland	353	500	
Israel	972	606	Disregard the figure "0" at head of subscriber number.
Italy	39	43	

Area and Country	Telephone Country Code	Telex Country Code	Remarks for Telex Code
Jamaica	1	291	
Japan		72	KDDI (for 5 digits)
	81		NTT
Jordan	962	493	
Kazakhstan	7	785	
Kenya	254	987	
Kiribati	686	761	Subscriber numbers are 770XX
Korea (Demo, People's Rep. of)	850	(899)	
Korea (Rep. of)	82	801	
Kuwait	965	496	
Kyrgyzstan	7	788	
Lao	856	804	
Latvia (formerly USSR)	371	538	
Lebanon	961	494	
Lesotho	266	963	
Liberia	231	997	
Libya	21	901	
Liechtenstein	41	45	
Lithuania (formerly USSR)	370	539	
Luxembourg	352	402	
Macao	853	808	
Macedonia	389	597	
Madagascar	261	986	Subscriber number beginning with 4, 5, 7, 8 and 9 can be reached by Manual Calls.
Madeira Is.	351	404	Destination code is the same as for Portugal.
Malawi	265	904	
Malaysia	60	84	
Maldives Is.	960	896	
Mali	223	985	
Malta	356	{ 406	Subscriber number beginning with 11XX can be reached by Semi-automatic calls.
		{ 403	
Mariana Is.	671	760	
Marshall Is.	692	765	
Maritinique	596	298	
Mauritania	222	974	
Mauritius	230	966	
Mexico	52	22	Disregard the figure "0" at head of subscriber number.
Micronesia	691	764	
Moldova	373	682	
Monaco	33	42	Destination code is the same as for France.
Mongolia	976	800	

APPENDIX

Area and Country	Telephone Country Code	Telex Country Code	Remarks for Telex Code
Montserrat	1	396	
Morocco	21	407	
Mozambique	258	992	
Myanmar (formerly Burma)	95	83	
Namibia	264	908	
Nauru	674	775	
Nepal	977	891	
Netherlands	31	44	
Netherlands Antilles	599	390	
New Caledonia	687	706	
New Zealand	64	74	
Nicaragua	505	375	
Niger	227	975	2XXXX other numbers are for Semi-automatic calls.
Nigeria	234	905	
Niue Is.	683	776	
Northern Mariana Is.	670		
Norfolk Is.	672	766	
Norway	47	56	
Oman	968	498	
Pakistan	92	82	
Palau	680	763	
Panama	507	377	TRT subscribers
		378	AACR subscribers
		379	INTEL subscribers
Papua New Guinea	675	703	
Paraguay	595	305	
Peru	51	36	
Philippines	63	75	PHILCOM subscribers 2XXXX
			RCPI subscribers 7XXXX
			GMCR subscribers 4XXXX
			ETPI subscribers 6XXXX
			CAPWIRE subscribers 1XXXX
			For PTT subscribers, insert the figure "8" after the destination code "75".
Poland	48	63	Disregard the figure "0" at head of subscriber number.
Portugal	351	404	
Puerto Rico	1	205	RCA subscribers 2XXX
		206	ITT subscribers 345XXX
		207	C&W, WUI subscribers
		209	ACPR (PRCA) subscribers
Qatar	974	497	

Area and Country	Telephone Country Code	Telex Country Code	Remarks for Telex Code
Reunion	262	961	Subscriber numbers are 916XXX
Romania	40	65	Disregard the figure "0" at head of subscriber number.
Russian Federation	7	64	
Rwanda	250	909	
Saipan	670	760	
San Marino	378	505	
Sao Tome & Principe	239	967	Manual calls
Saudi Arabia	966	495	
Senegal	221	906	
Seychelles	248	965	
Sierra Leone	232	998	
Singapore	65	87	
Slovak	42	66	
Slovenia	386	598	
Solomon Is.	677	778	
Somalia	252	900	
South Africa	27	95	{ Cape Town subscribers XXXXXX Bophuthatswana subscribers 08XXXX Transkei subscribers 09XXX
Spain	34	52	
Spanish North Africa	34	52	
Sri Lanka	94	803	
St. Helena	290	(960)	Manual calls 4XXX
St. Kitts & Nevis	1	397	
St. Lucia	1	398	
St. Pierre & Miquelon	508	204	
St. Vincent & the Grenadines	1	399	
Sudan	249	984	
Suriname	597	304	
Swaziland	268	964	
Sweden	46	54	
Switzerland	41	45	
Syria	963	492	
Tajikistan	7	787	
Taiwan	886	769	
Tanzania	255	989	
Thailand	66	86	
Togo	228	977	
Tokelau	690	762	
Tonga	676	777	
Trinidad & Tobago	296	294	
Tunisia	21	409	
Turkey	90	607	
Turkmenistan	7	789	

APPENDIX

Area and Country	Telephone Country Code	Telex Country Code	Remarks for Telex Code
Turks & Caicos Is.	1	296	
Tuvalu	688	774	
U. A. E.	971	893	
Abu Dhabi			2XXXX, 3XXXX, 5XXXX
Ajman			695XX
Dubai			4XXXX
Fujairah			8XXXX
Ras Al Khaimah			9XXXX
Sharjah			68XXX
Umm Al Qaiwain			697XX
Uganda	256	988	
Ukraine	7	680	
United Kingdom	44	51	
United Arab Emirates	971	893	
Upper Volta	226	978	Same as "Burkina Faso".
Uruguay	598	32	
Uzbekistan	7	786	
U. S. A.	1	23	{ CCI subscribers 7XXXXXX ITT subscribers 4XXXXX, 4XXXXXX, 4XXXXXXXXXX RCA subscribers 2XXXXX WUI subscribers 6XXXX, 6XXXXX, 6XXXXXX
U. S. A. (Mainland)		23	{ TRT subscribers 1XXXXX, 1XXXXXXXXXX FTCC subscribers 8XXXX, 8XXXXX GRPHNET subscribers 36XXXXX, 37XXXXX For WUT subscribers, insert the figure "0" after the destination code "23".
		25	{ Telex calls to TWX subscribers whose numbers do not contain "0" as the third figure of the 10 figure code can be made as Semi-automatic calls.
U. S. S. R. (Former)	7	640	Russian Federation
Vanuatu	678	771	
Vatican	379	504	
Venezuela	58	31	
Viet Nam	84	805	Subscriber number beginning with 561XXX can be made using manual calls
Wallis & Futuna Is.	681	707	
Western Samoa	685	779	
Yemen (Rep. of)	969	806	Formerly Yemen (P. D. Rep. of)
Yugoslavia (Former)	967	895	Formerly Yemen (Arab Rep.)

Area and Country	Telephone Country Code	Telex Country Code	Remarks for Telex Code
Zaire	243	982	Telex calls to places other than Kinshasa Subscriber beginning with 2XXXX can be made as Semi-automatic calls.
Zambia	260	902	
Zanzibar	259	990	
Zimbabwe	263	907	
Ocean Area	Telephone Ocean Region Access Code	Telex Ocean Region Access	Remarks
AOR-W	874	584	Atlantic Ocean-W
AOR-E	871	581	Atlantic Ocean-E
POR	872	582	Pacific Ocean
IOR	873	583	Indian Ocean

LES List

April/2003

Land earth station operator	Country	AOR- E	AOR- W	IOR	POR
Beijing Marine	China			311	211
Bezeq	Israel	127		327	
CAT	Thailand			319	
CP Radio Marconi	Portugal	118			
Embratel	Brazil	114			
France Telecom	France	121	021	321	221
France Telecom (Ex DeteSat)	France	115		333	
KDDI	Japan	103	003	303	203
Korea Telecom	South Korea			308	208
Morviasputnik (Nudel Les)	Russia	117		317	
OTE	Greece	120		305	
Polish Telecom	Poland	116		316	
Saudi Telecom Co	Saudi Arabia	125		325	
Singapore Telecom	Singapore			328	210
Stratos Mobile Networks	Canada	102	002	302	202
Telecom Company of Iran	Iran			314	
Telecom Italia	Italy	105		335	
Telenor Satellite Services Inc	USA	101	001		201
Telenor Satellite Services AS	Norway	104	004	304	204
Turk Telecom	Turkey	110		310	
Vishipel	Vietnam			330	
VSNL	India			306	
Xantic	Netherlands	112	012	312	212
Xantic	Australia	122	022	322	222

International Telex Abbreviations

Abbreviation	Meaning
ADV	Advise
ACK	Acknowledge
AGN	Again
BI (GS)	Good bye
BK	I cut off.
CFN	Confirm
COL	Collation
CRV	How do you receive?
DER	Out of order
DWN	Down
EEE	Error
FM	From
GA	Go ahead.
MNS	Minutes
MOM	Wait (Waiting)
MUTI	Mutilated
NA	Correspondence to this subscriber is not admitted.
NC	No circuits
NCH	Subscriber's number has been changed.
NP	The called party is not or no longer is a subscriber.
NR	Indicate your call number.
OCC	Subscriber is engaged.
OK	Agreed.
P (or 0)	Stop your transmission.
PLS (PSE)	Please
PPR	Paper
P (RCD)	Received
RAP	I will call you again.
RD	Reed
RE	Referring to
RPT	Repeat
SRY	Sorry
SVP	Please
TAX	What is the charge?
TEST MSG	Please send a test message?
THRU	You are in communication with telex position
TKS (TNX)	Thanks
TLX	Telex

International Telegraphy Alphabet

No.	FIGURES	LETTERS	No.	FIGURES	LETTERS
1	—	A	17	1	Q
2	?	B	18	4	R
3	:	C	19	'	S
4	⊕*	D	20	5	T
5	3	E	21	7	U
6	□*	F	22	=	V
7	■*	G	23	2	W
8	▣*	H	24	/	X
9	8	I	25	6	Y
10	BELL*	J	26	+	Z
11	(K	27	CARRIAGE RETURN	
12)	L	28	LINE FEED	
13	.	M	29	LETTERS	
14	,	N	30	FIGURES	
15	9	O	31	SPACE	
16	0	P	32	BLANK	

* = Cannot be entered.

Messages

Below are the various operational messages and their meanings. Messages are arranged according to function key.

[F1] File

1. "Overwrite?"
You are asked if you are sure to overwrite file name entered.
2. "OK to save?"
You are asked if you are sure to save a file.
3. "OK to delete file?"
You are asked if it is OK to delete selected file.
4. "Can't delete."
File cannot be deleted.
5. "Enter new filename"
Enter a new file name (to save file under new name.)
6. "Can't rename."
Cannot rename file.
7. "Press any key to escape."
Press any key to erase message displayed.
8. " Drive not ready."
No floppy disk in disk drive.
9. "Write protected."
Floppy disk is write protected.
10. " Drive error."
Floppy disk may be defective.
11. "Directory not found."
Directory specified could not be found.
12. "Checking "
Checking MIME-coded file.
13. "Decode ?"
Decode Base64 coded file.
14. "Now decoding..."
Decoding file.
15. "Complete."
File decoding completed.
16. "Decode failed. "
File could not be decoded.
17. "This terminal not support this code."
File could not be decoded because type of code not supported.
18. "Decoded 1 file(s)."
Decode MIME coded file.
19. "This file is not encoding."
Cannot encode file selected.
20. "File is already exist. Overwrite?"
File name encoded by MIME already exists.

[F3]: Transmit

1. "Input Error : Message File."
Invalid message selected for transmission.
2. "Input Error : Country/Ocean Code."
Invalid country/ocean code entered.
3. "Input Error : Station ID."
Invalid station ID entered.
4. "Input Error : Modem Type."
Invalid mode type entered. (For FAX, choose T30.)
5. "Input Error : E-Mail Address."
Invalid e-mail address entered.
6. "Input Error : LES ID."
Invalid LES ID entered.
7. "Input Error : Send Delay."
Invalid send delay time entered.
8. "Input Error : Prefix Code."
Invalid prefix code entered.
9. "Invalid character detected in message."
Invalid character found in TX message.
10. "Don't support E-Mail service in this NCS."
Selected NCS does not handle e-mail.
11. "Input Error : Too many stations."
You have selected too many stations to transmit to.
12. "Message file is too large (but send only with 32KB)."
The size of the file you want to send is larger than 32,000 bytes. (The file can be sent, but only the first 32,000 bytes of information will be received.)
13. "Attach file is too large."
The size of the attachment you want to send is larger than 32,000 bytes.
14. "Attach file (file name) is not found."
Cannot find attached file.
15. "Message is entered in sending Queue. Press any key."
Tx message entered into queue.
16. "Can't enter this message to sending Queue. Press any key."
Could not enter TX message into queue.
17. "The LES is out of service."
LES selected does not support Mini C.

[F5]: Data report

1. "Input Error : Country/Ocean Code."
Invalid country/ocean code entered.
2. "Input Error : Station ID."
Invalid station ID entered.
3. "Input Error : LES ID."
Invalid LES ID entered.
4. "Input Error : Interval Time"
Invalid interval time entered.
5. "Input Error : Start Time"
Invalid start time entered.

APPENDIX

6. "Input Error : Modem Type"
Invalid modem type entered.
7. "Input Error : Report Contents"
Invalid report contents entered.
8. "Input Error : Report Times"
Invalid number of report times entered.
9. "Input Error : Destination"
Invalid destination entered.
10. "Input Error : E-Mail Address"
Invalid e-mail address entered.
11. "Don't support E-Mail service in this NCS."
NCS does not handle e-mail.
12. "Input Error : Prefix Code"
Invalid prefix code entered.

[F7]: PV test

1. "Starting PV Test Process."
Going into PV test mode.
2. "Automatic test mode: Normal communication disabled."
Going into automatic test mode – all communications are disabled.
3. "Do not press any distress button unless you are in distress."
Do not operate the [DISTRESS] button except in an emergency.

Parts List

This equipment contains complex modules in which fault diagnosis and repair down to component level are not practical (IMO A.694(17)/8.3.1. Only some discrete components are used. FURUNO Electric Co., Ltd. believes identifying these components is of no value for shipboard maintenance; therefore, they are not listed in the manual. Major modules can be located on the parts location photos on the next several pages.

FURUNO		
ELECTRICAL PARTS LIST		
SYMBOL	TYPE	CODE No. REMARKS
COMMUNICATION UNIT IC-216		
	PRINTED CIRCUIT BOARD	
	16P0208B, RF CON/CPU	004 439 700
	16P0217, PWR	004 439 590
	16P0227, PWR C	004 439 470
	ASSEMBLY	
	GN 79L5A N, GN 79 (option)	000 146 179
ANTENNA UNIT IC-116		
	PRINTED CIRCUIT BOARD	
	ANTENNA CASE (ANT RF BOARD (16P0216))	004 439 580
	ANTENNA BASE	004 439 620
	ANTENNA ELEMENT (ANT B BOARD (16P0206))	004 439 010

Parts Location

Communication unit

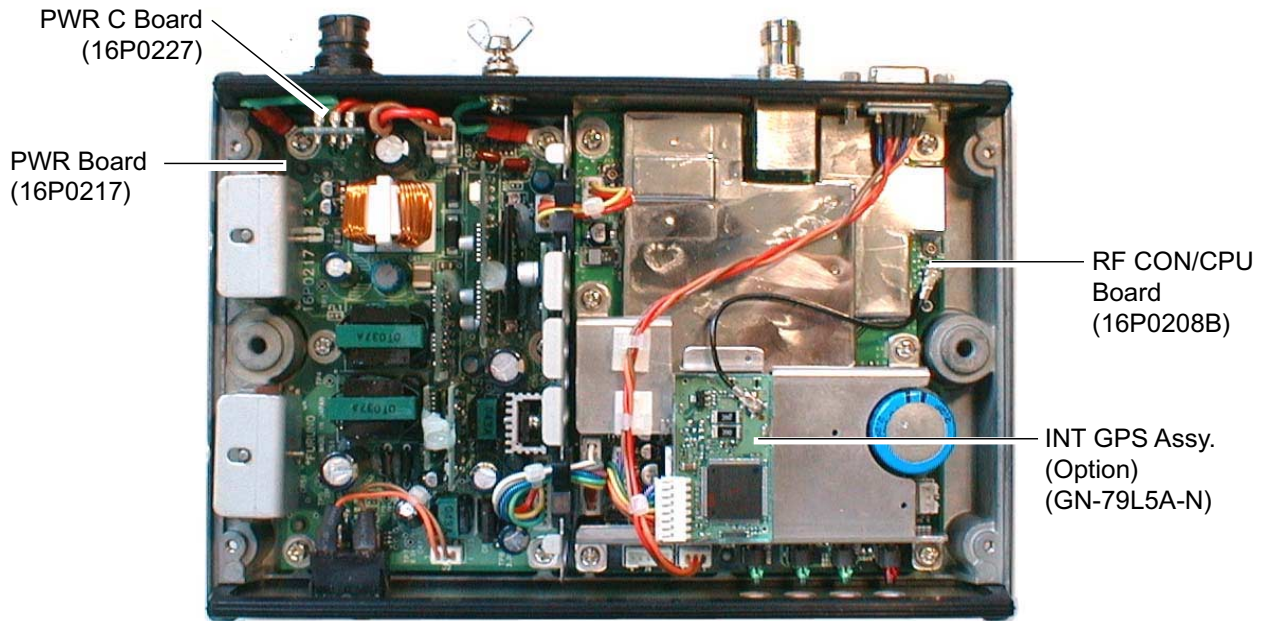

Communication unit, cover opened, INT GPS assy. installed

Antenna unit

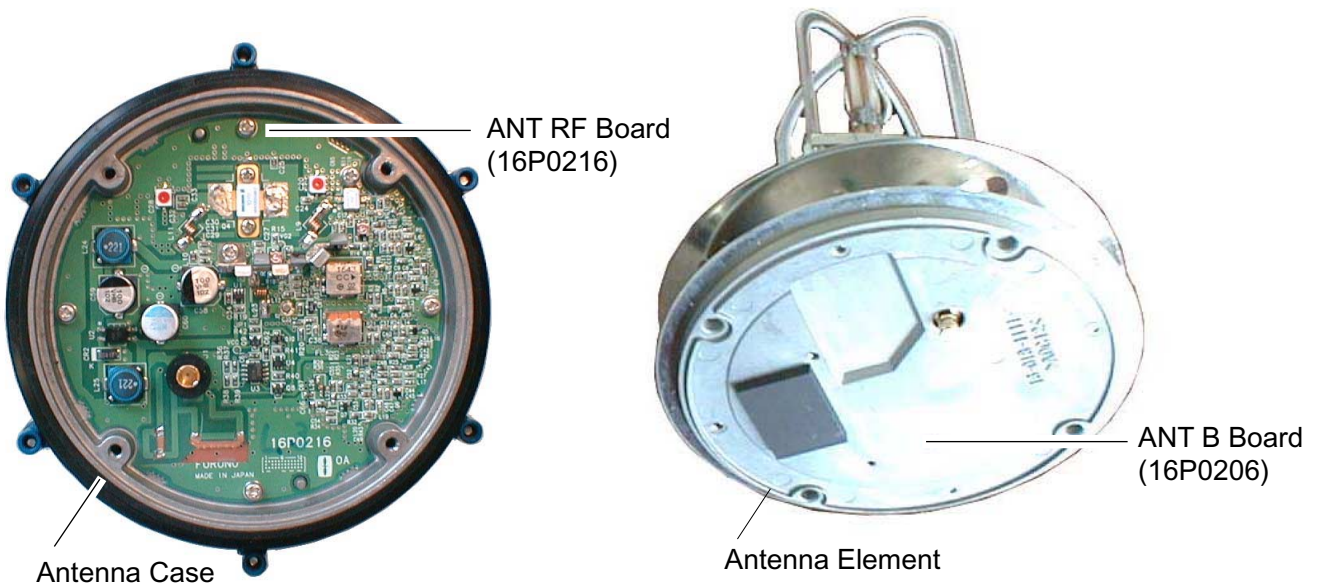

Antenna unit, cover opened

**SPECIFICATIONS OF INMARSAT C MES
FELCOM 16**

1 GENERAL

1.1	Transmitting Frequency	1626.5 to 1646.5 MHz
1.2	Receiving Frequency	1530.0 to 1545.0 MHz
1.3	Channel Interval	5 kHz
1.4	G/T	Better than -23 dB/K (elevation angle 5°)
1.5	EIRP	7 to 16 dBW (elevation angle 5°)
1.6	Modulation	BPSK
1.7	Modulation Rate	1200 sps
1.8	Coding	Convolution with coding rate 1/2 and constraint length 7
1.9	Decoding	Viterbi decoder
1.10	Internal GPS Board	GGA, ZDA, GLL, VTG, RMC, GSV (IEC61162-1)

2 ANTENNA UNIT

2.1	Antenna Type	Daisy Loop Antenna
2.2	Gain	
	Horizontal:	Omnidirectional
	Vertical:	0 dBi or more (angle of elevation: 90°) +1.3 dBi or more (angle of elevation: 5°)
2.3	Declination	Clockwise circular
2.4	Axial Ratio	Within 6 dB (5° to 90°)
2.5	VSWR	1.5 or less (50 ohm)

3 SOURCE

3.1	Communication Unit	12-24 VDC: 6.0-2.0 A (Transmit), 0.6-0.4 A (Receive)
-----	--------------------	--

4 ENVIRONMENTAL CONDITION

4.1	Ambient Temperature	
	Above deck equipment:	-35°C to +55°C
	Below deck equipment:	-15°C to +55°C
4.2	Relative Humidity	95% (at +40°C)
4.3	Waterproof (IEC 60529)	
	Antenna Unit	IPX6
	Communication Unit	IPX2
	Others	IPX0
4.4	Vibration	IEC 60945

5 COATING COLOR

5.1	Antenna Unit	Upper: N9.5, Lower: 2.5PB3.5/10
5.2	Communication Unit	Cover: N3.0, Panel: N1.0
5.3	Others	2.5GY5/1.5

This page is intentionally left blank.

INDEX

A

Aborting6-1

C

Colors

background2-3

foreground2-3

Communication unit

description1-1

testing7-2

Currency unit2-3

D

Data report

preparing5-2

printing5-7

Date

format2-3

manual input2-2

Delivery status

automatic confirmation4-17

manual confirmation4-19

Diagnostics7-2

Directory

creating2-31

specifying directory for message
storage2-33

Display indications1-7

DNID

displaying5-12

enabling/disabling5-13

E

Editor setup3-4

EGC

description2-8

EGC channels2-13

ENID4-34

message log4-35

message printing4-33

printing messages automatically2-16

receiving channel selection6-3

saving messages automatically2-15

setup2-10

E-mail

service list2-34

setup2-37

ENID4-34

Error messages7-9

F

Files

combining3-15

decoding MIME files3-18

deleting3-16

opening3-12

printing files on hard disk3-15

renaming3-17

saving3-10

saving under new name3-14

switching between two3-12

Function key description1-5

Fuse replacement7-8

I

Inmarsat C systemix

International telegraphy alphabet17

International telex abbreviations16

International telex/telephone country code
list8

L

LES

editing stations2-22

information6-5

list15

printing LES list2-23

registering stations2-21

setting toll charges2-19

Log

displaying4-31

printing (automatic)4-32

printing (manual)4-31

Logging in2-5

Logging out2-7

M

Maintenance7-1

Menu overview1-11

Menu treeAP-1

INDEX

- Message report..... 5-4
- Messages
 - deleting received..... 4-30
 - preparation of confidential 3-3
 - preparation of routine..... 3-2
 - printing received automatically 4-28
 - saving received automatically..... 4-29
- Messages (alerts) 18
- MIME 3-18
- N**
- NCS
 - adding channels..... 2-17
 - channel selection 6-4
 - scanning..... 6-2
- P**
- Parts list21
- Parts location22
- PC window setup 2-3
- Polling
 - printing commands..... 5-7
- Polling
 - commands..... 5-8
 - reception.....5-11
- Position input 2-30
- POWER switch (Communication unit) . 1-1
- Printer selection 1-13
- Printing
 - data report..... 5-7
 - EGC messages..... 4-33
 - EGC messages automatically 2-16
 - files on hard disk 3-15
 - LES list 2-23
 - Log (automatic)..... 4-32
 - Log (manual)..... 4-31
 - polling command..... 5-7
 - received messages (automatically) 4-28
 - station list 2-29
- Program no. list..... vii
- PV test
 - procedure 7-5
 - results 7-6
 - sequence..... 7-4
- R**
- Receiving
 - attachments..... 4-27
 - description..... 4-23
 - displaying received messages..... 4-24
 - printing received messages
 - (automatically) 4-28
 - receive alarm.....4-24
 - receive alarm on/off..... 4-24
 - saving received messages to hard disk
 - (automatically) 4-29
- Replacing text 3-8
- S**
- Saving
 - EGC messages automatically..... 2-15
 - file under new name..... 3-14
 - files 3-10
 - received messages to hard disk
 - (automatically) 4-29
 - received messages to hard disk
 - (manually) 4-28
- Searching text 3-7
- Send message log 4-22
- Shortcut key 1-4
- Standby display 1-6
- Station list
 - adding stations 2-24
 - editing stations 2-28
 - printing 2-29
- System configuration viii
- System settings
 - loading 2-38
 - saving 2-38
- System setup 2-1
- System status monitor 7-7
- T**
- Terminal setup menu 2-3
- Terminal unit
 - application startup, quitting 1-2
 - controls 1-3
- Text
 - copying and pasting 3-6
 - cutting and pasting 3-5
 - go to line 3-9
 - inserting 3-7
 - inserting time or position 3-9
 - replacing 3-8
 - searching 3-7
 - selecting all..... 3-7
- Transmitting
 - canceling 4-16
 - code number services 4-20

delivery status (automatic receipt) ..4-18
file stored on hard disk4-15
message to station not on station list4-8
message to station on station list.....4-2

W

Warning messages7-10
Window color.....2-3